

Základné údaje o výkone - WAMAK TWW 68 EVI

Vykurovanie - EN 14511		
Tepelný výkon [kW]	W10 / W35 (max)	71.9 (36.0 / 71.9)
	W10 / W35 (min)	36.0 (36.0 / 71.9)
	W10 / W34	71.9 (36.0 / 71.9)
Elektrický príkon [kW]	W10 / W35 (max)	11.6 (5.7 / 11.6)
	W10 / W35 (min)	5.7 (5.7 / 11.6)
	W10 / W34	11.2 (8.7 / 17.7)
Tepelná účinnosť [COP]	W10 / W35 (max)	6.22
	W10 / W35 (min)	6.31
	W10 / W34	6.40
Sezónna tepelná účinnosť vykurovania - SCOP EN 14825		
Stredná klim. zóna / Nízka teplota [35°C]	SCOP	7.35
	η [%]	293.8
	Label	A+++
	Qhe [kWh]	20179.2
	Pdesignh [kW]	71.9
	Tbivalent [°C]	-10
Chladenie		
Chladiaci výkon - [kW]	A35 / W23-18	56.8
	A25 / W23-18	60.0
	A35 / W12-7	41.9
	A25 / W12-7	41.9
Sezónna účinnosť chladenia - SEER EN 14825		
[W 23 / 18°C]	SEER	5.44
	Qce [kWh]	5813.5
	η_c [%]	217.4
Zvuk EN 12102		
Zvuk - výkon - Lw	dB(A)	58.9
Zvuk - tlak - Lp	1 m dB(A)	50.9
	5 m dB(A)	36.9
	10 m dB(A)	30.9
Strojné a prevádzkové informácie		
Typ kompresoru (3~ 400/50)	SCROLL / 2 /	Zap/Vyp
Chladivo	R410A (GWP - 2088)	6.8 kg
Prevádzkové hraničné teploty vykurovania - (min / max) [°C]		25 / 65
Prevádzkové hraničné teploty zdroja - (min / max) [°C]		-10 (7) / 30
Váha zariadenia		435 kg

Hlavné technické údaje - WAMAK TWW 68 EVI

Označenie krytovania			VN1100			Údaje strany odovzdania tepelnej energie		
Základné rozmery	Výška [mm]	1270	Prevádzkové hraničné teploty vykurovania	MAX [°C]	65			
	Šírka [mm]	1100		MIN [°C]	25			
	Dĺžka [mm]	750		viac vid. diagram prevádzkových limitov				
Váha zariadenia [kg]	435		Kondenzátor	Pripojovacia dimenzia	VIC 2.1/2 "			
Farba krytovania	Sivá			Typ	BPHE			
IP trieda krytovania	IP20			Počet	1			
				Materiál	AISI 316			
Chladivový okruh								
Kompresor	Typ	Scroll	Maximálny prevádzkový tlak - chladivo [bar]			50		
	Výkonové stupne	2	Maximálny prevádzkový tlak - Voda [bar]			6		
	Zap/Vyp		Testovací pretlak [bar]			70		
	Účinník Cosφ	0.69	Teplonosné médium			Voda		
	Odpor vynutia kompresora	1.24 Ohm	Objemový prietok @ dT 5K (nom) - Voda [m3/h]			6.22 ~ 12.44		
Chladivo		R410A	Vnútorná tlaková strata - Voda [kPa]			20		
	Objem	6.8 kg	Teplotný spád	@ 35°C (nom)	5 K			
	GWP	2088		@ 55°C	8 K			
	Bezpečnostná trieda	A1		@ 65°C	10 K			
Typ oleja v okruhu	POE RL32-3MAF		Údaje strany odberu obnoviteľnej energie					
	Objem oleja	2 x 3.38 L	Prevádzkové hraničné teploty zdroja	MIN [°C]	-10 (7)			
Maximálny tlak chladiva [bar]		50		MAX [°C]	30			
	PED trieda	2	viac vid. diagram prevádzkových limitov					
EVI - vstrek chladiva s ekonomizérom								
Údaje elektrického pripojenia								
Elektro napájanie [#~ V/Hz]	3~ 400/50							
Prúd	nominálny [A]	24.46						
	maximálny [A]	42.00						
	štartovací [A]	36.42						
Softštartér	-							
Hlavný istič - charakteristika	C80							
Riadiaci systém								
Hlavný regulátor	SIEMENS RVS 61							
Rozširovací modul	AVS75.3xx	AVS75.3xx	AVS75.372					
Bus Clip-In	Modbus OCI351							
Online pripojenie	Web server OZW672		ToSyMo					
Regulácia EEV	SEC61							

*** s príslušenstvom

WAMAK TWW 68 EVI

ErP (EU) No 811/2013: Technické parametre vykurovacích zariadení s tepelným čerpadlom

Model	TWW 68 EVI
Tepelné čerpadlo vzduch-voda	nie
Tepelné čerpadlo soľanka-voda	nie
Tepelné čerpadlo voda-voda	áno
Nízkotepelné tepelné čerpadlo	nie
Vybavené prídavným ohrievačom	nie
Kombinované tepelné čerpadlo s ohrievačom	nie
Teplotné použitie	nízka teplota (35 °C - 30 °C)
Klimatická oblasť	priemerná

Položka	Symbol	Hodnota	mj	Položka	Symbol	Hodnota	mj
Menovitý tepelný výkon pri Tdesignh	Prated	71.9	kW	Sezónna energetická účinnosť vykurovania priestoru	η_s	293.8	%
Deklarovaný výkon vykurovania pri čiastočnom zaťažení pri vnútornej teplote 20 °C a vonkajšej teplote Tj				Deklarovaný súčiniteľ výkonu alebo pomer primárnej energie pre čiastočné zaťaženie pri vnútornej teplote 20 °C a vonkajšej teplote Tj			
Tj = -7 °C	Pdh	71.9	kW	Tj = -7 °C	COPd	6.40	-
Tj = +2 °C	Pdh	71.9	kW	Tj = +2 °C	COPd	7.2	-
Tj = +7 °C	Pdh	71.8	kW	Tj = +7 °C	COPd	8.0	-
Tj = +12 °C	Pdh	71.6	kW	Tj = +12 °C	COPd	8.8	-
Tj = bivalentná teplota	Pdh	71.9	kW	Tj = bivalentná teplota	COPd	6.2	-
Tj = hraničná prevádzková teplota	Pdh	---	kW	Tj = hraničná prevádzková teplota	COPd	---	-
Bivalentná teplota	Tbiv	-10	°C	Tj = hraničná prevádzková teplota	TOL	---	°C
Spotreba energie v iných ako aktívnych režimoch				Medzná prevádzková teplota vykurovacej vody	WTOL	65	°C
Vypnuté	Poff	0.010	kW	Prídavný ohrievač			
Režim vypnutia termostatu	Pto	0.010	kW	Menovitý tepelný výkon	Psup	10.9	kW
Pohotovostný režim	Psb	0.010	kW	Typ príkonu energie	elektrická		
Režim ohrevu kľukovej skrine	Pck	0.000	kW				
Ostatné položky							
Regulácia výkonu	viacero stupňov			Pre tepelné čerpadlá vzduch-voda: Menovitý prietok vzduchu, vonku	-	---	m ³ /h
Úroveň akustického výkonu				Pre tepelné čerpadlá voda-voda alebo soľanka-voda: Menovitý prietok soľanky alebo vody, vonkajší výmenník tepla	-	6.53 ~ 13.05	m ³ /h
v interiéri	Lwa	59	dB				
vonku	Lwa	---	dB				
Ročná spotreba energie	Q _{HE}	20179.2	kWh				

Kontaktné údaje: WAMAK, s.r.o., Orovnica 252, 96652, Orovnica, Slovakia, info@wamak.sk

WAMAK TWW 68 EVI

ErP (EU) No 811/2013: Technické parametre vykurovacích zariadení s tepelným čerpadlom

Model	TWW 68 EVI
Tepelné čerpadlo vzduch-voda	nie
Tepelné čerpadlo soľanka-voda	nie
Tepelné čerpadlo voda-voda	áno
Nízkotepelné tepelné čerpadlo	nie
Vybavené prídavným ohrievačom	nie
Kombinované tepelné čerpadlo s ohrievačom	nie
Teplotné použitie	stredá teplota (55°C - 47°C)
Klimatická oblasť	priemerná

Položka	Symbol	Hodnota	mj	Položka	Symbol	Hodnota	mj
Menovitý tepelný výkon pri Tdesignh	Prated	71.6	kW	Sezónna energetická účinnosť vykurovania priestoru	η_s	214.7	%
Deklarovaný výkon vykurovania pri čiastočnom zaťažení pri vnútornej teplote 20 °C a vonkajšej teplote Tj				Deklarovaný súčiniteľ výkonu alebo pomer primárnej energie pre čiastočné zaťaženie pri vnútornej teplote 20 °C a vonkajšej teplote Tj			
Tj = -7 °C	Pdh	72.4	kW	Tj = -7 °C	COPd	4.09	-
Tj = +2 °C	Pdh	72.7	kW	Tj = +2 °C	COPd	5.5	-
Tj = +7 °C	Pdh	72.7	kW	Tj = +7 °C	COPd	6.5	-
Tj = +12 °C	Pdh	72.7	kW	Tj = +12 °C	COPd	7.4	-
Tj = bivalentná teplota	Pdh	71.6	kW	Tj = bivalentná teplota	COPd	3.6	-
Tj = hraničná prevádzková teplota	Pdh	---	kW	Tj = hraničná prevádzková teplota	COPd	---	-
Bivalentná teplota	Tbiv	-10	°C	Tj = hraničná prevádzková teplota	TOL	---	°C
Spotreba energie v iných ako aktívnych režimoch				Medzná prevádzková teplota vykurovacej vody	WTOL	65	°C
Vypnuté	Poff	0.010	kW	Prídavný ohrievač			
Režim vypnutia termostatu	Pto	0.010	kW	Menovitý tepelný výkon	Psup	10.9	kW
Pohotovostný režim	Psb	0.010	kW	Typ príkonu energie	elektrická		
Režim ohrevu kľukovej skrine	Pck	0.000	kW				
Ostatné položky							
Regulácia výkonu	viacero stupňov			Pre tepelné čerpadlá vzduch-voda: Menovitý prietok vzduchu, vonku	-	---	m ³ /h
Úroveň akustického výkonu				Pre tepelné čerpadlá voda-voda alebo soľanka-voda: Menovitý prietok soľanky alebo vody, vonkajší výmenník tepla	-	6.53 ~ 13.05	m ³ /h
v interiéri	Lwa	59	dB				
vonku	Lwa	---	dB				
Ročná spotreba energie	Q _{HE}	27519.6	kWh				

Kontaktné údaje: WAMAK, s.r.o., Orovnica 252, 96652, Orovnica, Slovakia, info@wamak.sk



ENERG Y IIA
 енергия - ενεργεια IE IA

WAMAK

TWW 68 EVI



55 °C

35 °C



A+++

A+++



59 dB



--- dB

■ 76
 ■ 72
 ■ 71
 kW

■ 74
 ■ 72
 ■ 69
 kW



2019

811/2013

TWW 68 EVI

ErP Data

	55 °C	35 °C
Energy class	A+++	A+++
η [%]	214.7	293.8
P_{rated} [kW]	72	72
Q_{HE} [kWh/y]	27520	20180
SCOP [-]	5.37	7.35
$T_{bivalent}$ [°C]	-10	-10

CONTROLLER



+ QAA55/75
 - QAA55/75

class VII
 class III

3.5% ↓
 1.5% ↓

Tepelný výkon - prevádzkové dáta

Version: v2024.004-BW-WW

Zdroj - soľanka [0°C] / Nízka teplota [35°C]

ZHI27K1P-TFD_R410A_2_BWW

Prevádzkový bod	Qh	P	COP
1 B0 / W30-35	56.9	12.2	4.68
2 B0 / W30-35 (MIN)	28.5	6.0	4.75
A B0 / Wxx-34	56.9	11.9	4.80
B B0 / Wxx-30	56.8	10.8	5.28
C B0 / Wxx-27	28.4	4.9	5.75
D B0 / Wxx-24	28.3	4.6	6.20
E B0 / Wxx-35	56.9	12.2	4.68
F B0 / Wxx-35	56.9	12.2	4.68

SCOP DATA EN 14825:2018	
Zdroj - soľanka [0°C] / Nízka teplota [35°C]	
SCOPon	5.39
SCOPnet	5.39
SCOP	5.38
η [%]	215.12
Label	A+++
Qh [kWh]	117555
Pdesignh [kW]	56.9
Tbivalent [°C]	-10

Zdroj - soľanka [0°C] / Stredná teplota [55°C]

Prevádzkový bod	Qh	P	COP
1 B0 / W47-55	57.5	19.9	2.88
2 B0 / W47-55 (MIN)	28.8	9.7	2.92
A B0 / Wxx-52	57.9	18.0	3.34
B B0 / Wxx-42	58.4	13.7	4.32
C B0 / Wxx-36	28.8	5.9	4.87
D B0 / Wxx-30	28.8	5.3	5.43
E B0 / Wxx-55	57.5	19.9	2.88
F B0 / Wxx-54	58.0	18.5	3.14

SCOP DATA EN 14825:2018	
Zdroj - soľanka [0°C] / Stredná teplota [55°C]	
SCOPon	4.19
SCOPnet	4.19
SCOP	4.18
η [%]	167.36
Label	A+++
Qh [kWh]	118795
Pdesignh [kW]	57.5
Tbivalent [°C]	-10

Zdroj - voda [10°C] / Nízka teplota [35°C]

Prevádzkový bod	Qh	P	COP
1 W10 / W30-35	71.9	11.6	6.22
2 W10 / W30-35 (MIN)	36.0	5.7	6.31
A W10 / Wxx-34	71.9	11.2	6.40
B W10 / Wxx-30	71.9	10.0	7.18
C W10 / Wxx-27	35.9	4.5	7.96
D W10 / Wxx-24	35.8	4.1	8.76
E W10 / Wxx-35	71.9	11.6	6.22
F W10 / Wxx-35	71.9	11.6	6.22

SCOP DATA EN 14825:2018	
Zdroj - voda [10°C] / Nízka teplota [35°C]	
SCOPon	7.36
SCOPnet	7.36
SCOP	7.35
η [%]	293.84
Label	A+++
Qh [kWh]	148545
Pdesignh [kW]	71.9
Tbivalent [°C]	-10.00

Zdroj - voda [10°C] / Stredná teplota [55°C]

	Prevádzkový bod	Qh	P	COP
1	W10 / W47-55	71.6	19.7	3.63
2	W10 / W47-55 (MIN)	35.8	9.7	3.68
A	W10 / Wxx-52	72.4	17.7	4.09
B	W10 / Wxx-42	72.7	13.2	5.50
C	W10 / Wxx-36	36.4	5.6	6.50
D	W10 / Wxx-30	36.3	4.9	7.40
E	W10 / Wxx-55	71.6	19.7	3.63
F	W10 / Wxx-55	71.6	19.7	3.63

SCOP DATA EN 14825:2018	
Zdroj - voda [10°C] / Stredná teplota [55°C]	
SCOPon	5.37
SCOPnet	5.37
SCOP	5.37
η [%]	214.67
Label	A+++
Qh [kWh]	147926
Pdesignh [kW]	71.6
Tbivalent [°C]	-10.00

Nízkokoteplotné chladenie W 12 / 7°C

	Prevádzkový bod	Qc	P	EER
A	W30-35 / W12-7	43.4	13.1	3.31
B	W26-xx / W12-7	44.4	11.9	3.73
C	W22-xx / W12-7	45.3	10.8	4.19
D	W18-xx / W12-7	45.8	10.3	4.44

SEER DATA EN 14825:2018 [W 12 / 7°C]	
SEERon	4.05
SEER	4.05
Qc [kWh]	25140
η [%]	161.91

Plošné chladenie W 23 / 18°C

	Prevádzkový bod	Qc	P	EER
A	W50-xx / W23-18	50.2	21.6	2.33
B	W40-xx / W23-18	54.8	16.7	3.28
C	W30-35 / W23-18	58.5	13.1	4.47
D	W26-xx / W23-18	59.8	11.9	5.02

SEER DATA EN 14825:2018 [W 23 / 18°C]	
SEERon	5.44
SEER	5.44
Qc [kWh]	25140
η [%]	217.40

Výkonové kryvky - vykurovanie

— Qh-nom-35
 - - - Qh-min-35
 - - - Qh-max-65
 — Qh-nom-45
 — Qh-nom-55
— Qh-nom-65

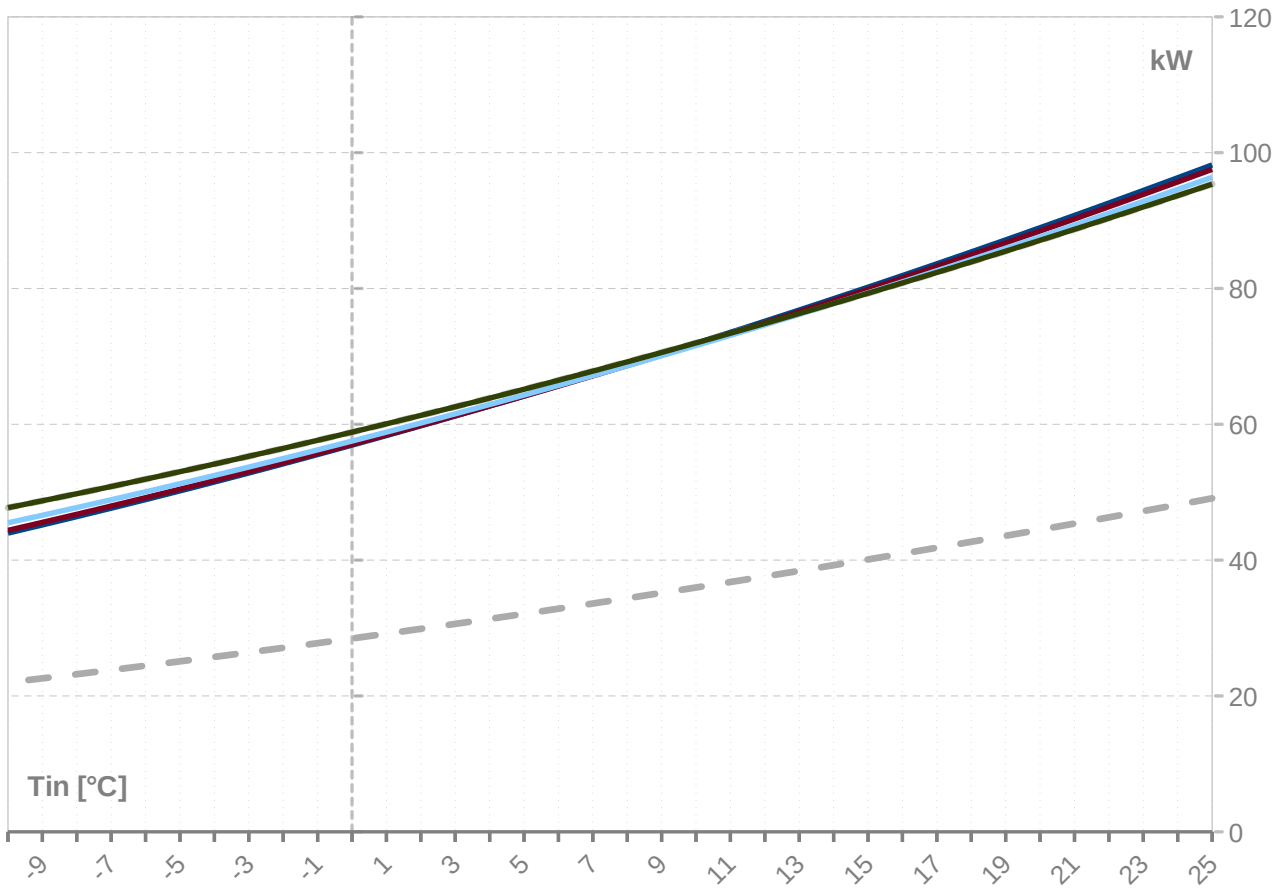

Výkonové kryvky - chladenie

— Qc-nom-12-7
 — Qc-nom-23-18

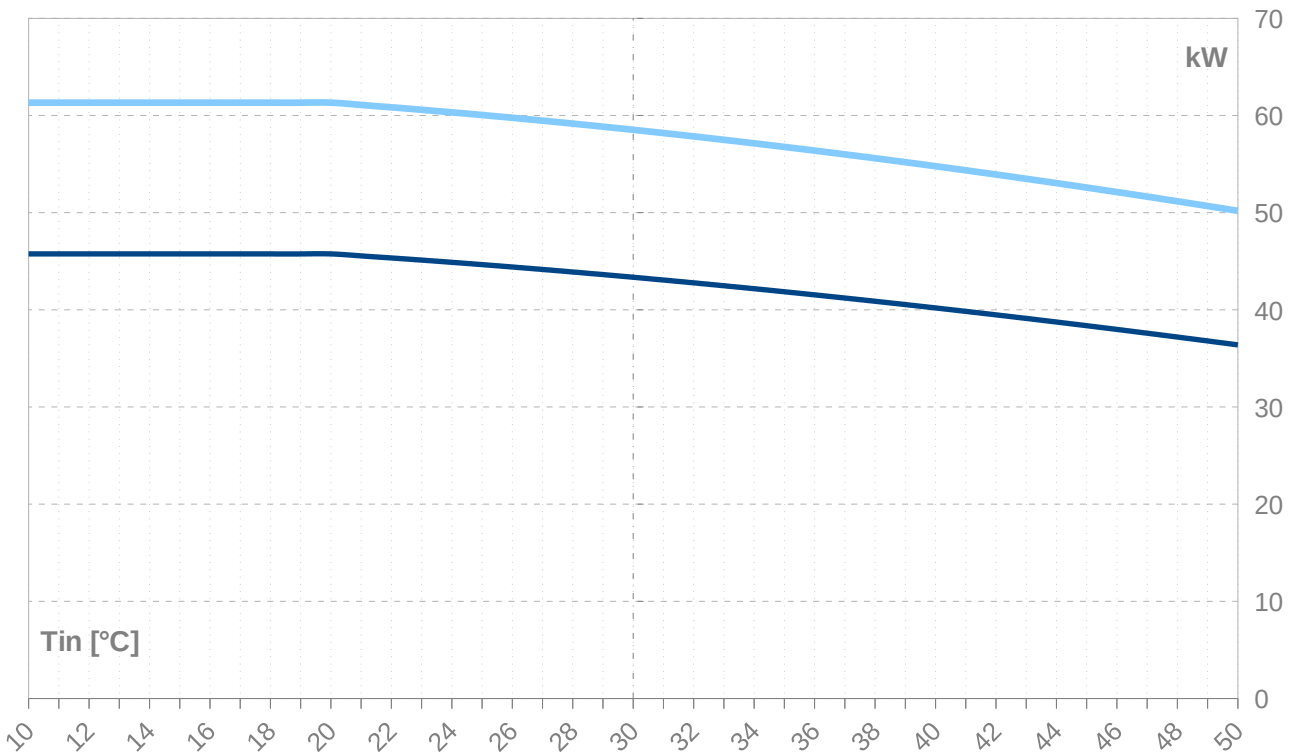

Tv -VY		35										
Tz -VS [°C]	Qh nom [kW]	Qh min [kW]	Qh max [kW]	Pin nom [kW]	Pin min [kW]	Pin max [kW]	COP nom kW / kW	Qc nom [kW]	Qc min [kW]	Qc max [kW]	I nom [A]	
25	98.2	49.1	98.2	9.4	4.6	9.4	10.50	89.5	44.7	89.5	22.3	
24	96.3	48.2	96.3	9.6	4.7	9.6	10.07	87.4	43.7	87.4	22.5	
23	94.4	47.2	94.4	9.8	4.8	9.8	9.68	85.3	42.7	85.3	22.6	
22	92.6	46.3	92.6	9.9	4.9	9.9	9.31	83.3	41.6	83.3	22.7	
21	90.8	45.4	90.8	10.1	5.0	10.1	8.96	81.3	40.7	81.3	22.9	
20	88.9	44.5	88.9	10.3	5.1	10.3	8.64	79.3	39.7	79.3	23.0	
19	87.2	43.6	87.2	10.5	5.2	10.5	8.33	77.4	38.7	77.4	23.1	
18	85.4	42.7	85.4	10.6	5.2	10.6	8.05	75.5	37.7	75.5	23.2	
17	83.6	41.8	83.6	10.8	5.3	10.8	7.77	73.6	36.8	73.6	23.3	
16	81.9	41.0	81.9	10.9	5.4	10.9	7.52	71.7	35.9	71.7	23.5	
15	80.2	40.1	80.2	11.0	5.4	11.0	7.27	69.9	34.9	69.9	23.6	
14	78.5	39.3	78.5	11.1	5.5	11.1	7.04	68.1	34.0	68.1	23.7	
13	76.8	38.4	76.8	11.3	5.6	11.3	6.82	66.3	33.2	66.3	23.8	
12	75.2	37.6	75.2	11.4	5.6	11.4	6.61	64.6	32.3	64.6	23.8	
11	73.5	36.8	73.5	11.5	5.7	11.5	6.41	62.8	31.4	62.8	23.9	
10	71.9	36.0	71.9	11.6	5.7	11.6	6.22	61.1	30.6	61.1	24.0	
9	70.3	35.2	70.3	11.6	5.7	11.6	6.04	59.5	29.7	59.5	24.1	
8	68.8	34.4	68.8	11.7	5.8	11.7	5.87	57.8	28.9	57.8	24.2	
7	67.2	33.6	67.2	11.8	5.8	11.8	5.70	56.2	28.1	56.2	24.3	
6	65.7	32.8	65.7	11.9	5.9	11.9	5.54	54.6	27.3	54.6	24.3	
5	64.2	32.1	64.2	11.9	5.9	11.9	5.38	53.0	26.5	53.0	24.4	
4	62.7	31.3	62.7	12.0	5.9	12.0	5.23	51.5	25.7	51.5	24.5	
3	61.2	30.6	61.2	12.0	5.9	12.0	5.09	50.0	25.0	50.0	24.5	
2	59.8	29.9	59.8	12.1	6.0	12.1	4.95	48.5	24.2	48.5	24.6	
1	58.3	29.2	58.3	12.1	6.0	12.1	4.81	47.0	23.5	47.0	24.6	
0	56.9	28.5	56.9	12.2	6.0	12.2	4.68	45.6	22.8	45.6	24.7	
-1	55.5	27.8	55.5	12.2	6.0	12.2	4.56	44.2	22.1	44.2	24.7	
-2	54.2	27.1	54.2	12.2	6.0	12.2	4.44	42.8	21.4	42.8	24.7	
-3	52.8	26.4	52.8	12.2	6.0	12.2	4.32	41.4	20.7	41.4	24.8	
-4	51.5	25.7	51.5	12.3	6.0	12.3	4.20	40.1	20.0	40.1	24.8	
-5	50.2	25.1	50.2	12.3	6.1	12.3	4.09	38.7	19.4	38.7	24.8	
-6	48.9	24.5	48.9	12.3	6.1	12.3	3.98	37.4	18.7	37.4	24.9	
-7	47.6	23.8	47.6	12.3	6.1	12.3	3.88	36.2	18.1	36.2	24.9	
-8	46.4	23.2	46.4	12.3	6.1	12.3	3.77	34.9	17.5	34.9	24.9	
-9	45.2	22.6	45.2	12.3	6.1	12.3	3.67	33.7	16.8	33.7	24.9	
-10	44.0	22.0	44.0	12.3	6.1	12.3	3.58	32.5	16.2	32.5	24.9	
-11	42.8	21.4	42.8	12.3	6.1	12.3	3.48	31.3	15.7	31.3	24.9	
-12	41.6	20.8	41.6	12.3	6.1	12.3	3.39	30.2	15.1	30.2	24.9	
-13	40.5	20.2	40.5	12.3	6.1	12.3	3.30	29.0	14.5	29.0	24.9	
-14	39.4	19.7	39.4	12.3	6.1	12.3	3.21	27.9	14.0	27.9	24.9	
-15	38.3	19.1	38.3	12.3	6.1	12.3	3.12	26.8	13.4	26.8	24.9	

-- pozor: pracovný rozsah nie je zohľadnený v tabuľke

ZHI27K1P-TFD_R410A_2_BWW

Tv -VY	45										
[°C]	Qh nom [kW]	Qh min [kW]	Qh max [kW]	Pin nom [kW]	Pin min [kW]	Pin max [kW]	COP nom kW / kW	Qc nom [kW]	Qc min [kW]	Qc max [kW]	I nom [A]
25	97.5	48.8	97.5	13.3	6.6	13.3	7.34	85.1	42.6	85.1	26.0
24	95.7	47.8	95.7	13.4	6.6	13.4	7.12	83.1	41.6	83.1	26.1
23	93.8	46.9	93.8	13.6	6.7	13.6	6.90	81.1	40.6	81.1	26.3
22	92.0	46.0	92.0	13.7	6.8	13.7	6.70	79.2	39.6	79.2	26.4
21	90.2	45.1	90.2	13.9	6.8	13.9	6.50	77.3	38.6	77.3	26.6
20	88.5	44.2	88.5	14.0	6.9	14.0	6.31	75.4	37.7	75.4	26.7
19	86.7	43.3	86.7	14.1	7.0	14.1	6.13	73.5	36.7	73.5	26.8
18	85.0	42.5	85.0	14.3	7.0	14.3	5.96	71.6	35.8	71.6	26.9
17	83.2	41.6	83.2	14.4	7.1	14.4	5.80	69.8	34.9	69.8	27.0
16	81.5	40.8	81.5	14.5	7.1	14.5	5.64	68.0	34.0	68.0	27.1
15	79.9	39.9	79.9	14.6	7.2	14.6	5.49	66.3	33.1	66.3	27.3
14	78.2	39.1	78.2	14.6	7.2	14.6	5.34	64.5	32.3	64.5	27.4
13	76.6	38.3	76.6	14.7	7.3	14.7	5.20	62.8	31.4	62.8	27.4
12	74.9	37.5	74.9	14.8	7.3	14.8	5.06	61.1	30.6	61.1	27.5
11	73.3	36.7	73.3	14.9	7.3	14.9	4.93	59.4	29.7	59.4	27.6
10	71.8	35.9	71.8	14.9	7.4	14.9	4.81	57.8	28.9	57.8	27.7
9	70.2	35.1	70.2	15.0	7.4	15.0	4.68	56.2	28.1	56.2	27.8
8	68.7	34.3	68.7	15.0	7.4	15.0	4.56	54.6	27.3	54.6	27.9
7	67.1	33.6	67.1	15.1	7.4	15.1	4.45	53.0	26.5	53.0	27.9
6	65.6	32.8	65.6	15.1	7.5	15.1	4.34	51.5	25.7	51.5	28.0
5	64.1	32.1	64.1	15.2	7.5	15.2	4.23	50.0	25.0	50.0	28.0
4	62.7	31.3	62.7	15.2	7.5	15.2	4.12	48.5	24.2	48.5	28.1
3	61.2	30.6	61.2	15.2	7.5	15.2	4.02	47.0	23.5	47.0	28.2
2	59.8	29.9	59.8	15.3	7.5	15.3	3.92	45.6	22.8	45.6	28.2
1	58.4	29.2	58.4	15.3	7.5	15.3	3.82	44.1	22.1	44.1	28.2
0	57.0	28.5	57.0	15.3	7.5	15.3	3.73	42.8	21.4	42.8	28.3
-1	55.7	27.8	55.7	15.3	7.6	15.3	3.63	41.4	20.7	41.4	28.3
-2	54.3	27.2	54.3	15.3	7.6	15.3	3.54	40.0	20.0	40.0	28.3
-3	53.0	26.5	53.0	15.3	7.6	15.3	3.46	38.7	19.4	38.7	28.4
-4	51.7	25.9	51.7	15.3	7.6	15.3	3.37	37.4	18.7	37.4	28.4
-5	50.5	25.2	50.5	15.4	7.6	15.4	3.29	36.1	18.1	36.1	28.4
-6	49.2	24.6	49.2	15.4	7.6	15.4	3.20	34.9	17.4	34.9	28.4
-7	48.0	24.0	48.0	15.4	7.6	15.4	3.12	33.6	16.8	33.6	28.4
-8	46.7	23.4	46.7	15.4	7.6	15.4	3.05	32.4	16.2	32.4	28.4
-9	45.6	22.8	45.6	15.3	7.6	15.3	2.97	31.2	15.6	31.2	28.4
-10	44.4	22.2	44.4	15.3	7.6	15.3	2.89	30.1	15.0	30.1	28.4
-11	43.2	21.6	43.2	15.3	7.6	15.3	2.82	28.9	14.5	28.9	28.4
-12	42.1	21.1	42.1	15.3	7.6	15.3	2.75	27.8	13.9	27.8	28.4
-13	41.0	20.5	41.0	15.3	7.6	15.3	2.68	26.7	13.3	26.7	28.4
-14	39.9	20.0	39.9	15.3	7.6	15.3	2.61	25.6	12.8	25.6	28.4
-15	38.8	19.4	38.8	15.3	7.5	15.3	2.54	24.6	12.3	24.6	28.3

-- pozor: pracovný rozsah nie je zohľadnený v tabuľke

Tv -VY	55										
[°C]	Qh nom [kW]	Qh min [kW]	Qh max [kW]	Pin nom [kW]	Pin min [kW]	Pin max [kW]	COP nom kW / kW	Qc nom [kW]	Qc min [kW]	Qc max [kW]	I nom [A]
25	96.4	48.2	96.4	18.5	9.1	18.5	5.21	79.1	39.5	79.1	31.9
24	94.6	47.3	94.6	18.6	9.2	18.6	5.08	77.2	38.6	77.2	32.1
23	92.8	46.4	92.8	18.7	9.2	18.7	4.95	75.3	37.7	75.3	32.2
22	91.1	45.5	91.1	18.9	9.3	18.9	4.83	73.5	36.7	73.5	32.4
21	89.3	44.7	89.3	19.0	9.4	19.0	4.71	71.6	35.8	71.6	32.5
20	87.6	43.8	87.6	19.1	9.4	19.1	4.60	69.8	34.9	69.8	32.6
19	85.9	43.0	85.9	19.1	9.4	19.1	4.49	68.1	34.0	68.1	32.7
18	84.3	42.1	84.3	19.2	9.5	19.2	4.38	66.3	33.2	66.3	32.9
17	82.6	41.3	82.6	19.3	9.5	19.3	4.28	64.6	32.3	64.6	33.0
16	81.0	40.5	81.0	19.4	9.6	19.4	4.18	62.9	31.4	62.9	33.1
15	79.4	39.7	79.4	19.5	9.6	19.5	4.08	61.2	30.6	61.2	33.2
14	77.8	38.9	77.8	19.5	9.6	19.5	3.99	59.5	29.8	59.5	33.3
13	76.2	38.1	76.2	19.6	9.7	19.6	3.89	57.9	29.0	57.9	33.4
12	74.6	37.3	74.6	19.6	9.7	19.6	3.80	56.3	28.2	56.3	33.4
11	73.1	36.6	73.1	19.7	9.7	19.7	3.72	54.7	27.4	54.7	33.5
10	71.6	35.8	71.6	19.7	9.7	19.7	3.63	53.2	26.6	53.2	33.6
9	70.1	35.0	70.1	19.8	9.7	19.8	3.55	51.6	25.8	51.6	33.7
8	68.6	34.3	68.6	19.8	9.8	19.8	3.47	50.1	25.1	50.1	33.7
7	67.2	33.6	67.2	19.8	9.8	19.8	3.39	48.7	24.3	48.7	33.8
6	65.7	32.9	65.7	19.8	9.8	19.8	3.31	47.2	23.6	47.2	33.8
5	64.3	32.2	64.3	19.9	9.8	19.9	3.24	45.8	22.9	45.8	33.9
4	62.9	31.5	62.9	19.9	9.8	19.9	3.16	44.3	22.2	44.3	33.9
3	61.5	30.8	61.5	19.9	9.8	19.9	3.09	42.9	21.5	42.9	34.0
2	60.2	30.1	60.2	19.9	9.8	19.9	3.02	41.6	20.8	41.6	34.0
1	58.8	29.4	58.8	19.9	9.8	19.9	2.95	40.2	20.1	40.2	34.0
0	57.5	28.8	57.5	19.9	9.8	19.9	2.88	38.9	19.4	38.9	34.0
-1	56.2	28.1	56.2	20.0	9.8	20.0	2.82	37.6	18.8	37.6	34.1
-2	55.0	27.5	55.0	20.0	9.8	20.0	2.75	36.3	18.2	36.3	34.1
-3	53.7	26.9	53.7	20.0	9.8	20.0	2.69	35.1	17.5	35.1	34.1
-4	52.5	26.2	52.5	20.0	9.8	20.0	2.63	33.8	16.9	33.8	34.1
-5	51.3	25.6	51.3	20.0	9.9	20.0	2.57	32.6	16.3	32.6	34.1
-6	50.1	25.0	50.1	20.0	9.9	20.0	2.51	31.4	15.7	31.4	34.1
-7	48.9	24.4	48.9	20.0	9.9	20.0	2.45	30.2	15.1	30.2	34.1
-8	47.7	23.9	47.7	20.0	9.9	20.0	2.39	29.1	14.5	29.1	34.1
-9	46.6	23.3	46.6	20.0	9.9	20.0	2.33	28.0	14.0	28.0	34.0
-10	45.5	22.7	45.5	20.0	9.9	20.0	2.28	26.8	13.4	26.8	34.0
-11	44.4	22.2	44.4	20.0	9.9	20.0	2.22	25.8	12.9	25.8	34.0
-12	43.3	21.7	43.3	20.0	9.9	20.0	2.17	24.7	12.3	24.7	33.9
-13	42.3	21.1	42.3	20.0	9.9	20.0	2.12	23.6	11.8	23.6	33.9
-14	41.3	20.6	41.3	20.0	9.9	20.0	2.07	22.6	11.3	22.6	33.9
-15	40.3	20.1	40.3	20.0	9.9	20.0	2.02	21.6	10.8	21.6	33.8

-- pozor: pracovný rozsah nie je zohľadnený v tabuľke

Tv -VY	[°C]	65 (T-max)									
		Tz -VS [°C]	Qh nom [kW]	Qh min [kW]	Qh max [kW]	Pin nom [kW]	Pin min [kW]	Pin max [kW]	COP nom kW / kW	Qc nom [kW]	Qc min [kW]
25	95.4	47.7	95.4	24.8	12.2	24.8	3.85	72.2	36.1	72.2	39.8
24	93.7	46.8	93.7	24.9	12.3	24.9	3.77	70.4	35.2	70.4	39.9
23	92.0	46.0	92.0	25.0	12.3	25.0	3.68	68.7	34.3	68.7	40.1
22	90.3	45.2	90.3	25.1	12.4	25.1	3.61	66.9	33.5	66.9	40.2
21	88.7	44.4	88.7	25.1	12.4	25.1	3.53	65.2	32.6	65.2	40.3
20	87.1	43.5	87.1	25.2	12.4	25.2	3.45	63.5	31.8	63.5	40.5
19	85.5	42.7	85.5	25.3	12.5	25.3	3.38	61.9	30.9	61.9	40.6
18	83.9	42.0	83.9	25.3	12.5	25.3	3.31	60.2	30.1	60.2	40.7
17	82.4	41.2	82.4	25.4	12.5	25.4	3.24	58.6	29.3	58.6	40.8
16	80.8	40.4	80.8	25.5	12.6	25.5	3.17	57.0	28.5	57.0	40.9
15	79.3	39.6	79.3	25.5	12.6	25.5	3.11	55.5	27.7	55.5	41.0
14	77.8	38.9	77.8	25.6	12.6	25.6	3.04	53.9	27.0	53.9	41.1
13	76.3	38.2	76.3	25.6	12.6	25.6	2.98	52.4	26.2	52.4	41.1
12	74.8	37.4	74.8	25.6	12.7	25.6	2.92	50.9	25.4	50.9	41.2
11	73.4	36.7	73.4	25.7	12.7	25.7	2.86	49.4	24.7	49.4	41.3
10	72.0	36.0	72.0	25.7	12.7	25.7	2.80	48.0	24.0	48.0	41.3
9	70.6	35.3	70.6	25.8	12.7	25.8	2.74	46.5	23.3	46.5	41.4
8	69.2	34.6	69.2	25.8	12.7	25.8	2.68	45.1	22.6	45.1	41.4
7	67.8	33.9	67.8	25.8	12.7	25.8	2.63	43.7	21.9	43.7	41.5
6	66.5	33.2	66.5	25.8	12.7	25.8	2.57	42.4	21.2	42.4	41.5
5	65.2	32.6	65.2	25.9	12.7	25.9	2.52	41.0	20.5	41.0	41.6
4	63.9	31.9	63.9	25.9	12.8	25.9	2.47	39.7	19.8	39.7	41.6
3	62.6	31.3	62.6	25.9	12.8	25.9	2.42	38.4	19.2	38.4	41.6
2	61.3	30.7	61.3	25.9	12.8	25.9	2.37	37.1	18.6	37.1	41.6
1	60.1	30.0	60.1	25.9	12.8	25.9	2.32	35.9	17.9	35.9	41.6
0	58.8	29.4	58.8	25.9	12.8	25.9	2.27	34.6	17.3	34.6	41.6
-1	57.6	28.8	57.6	25.9	12.8	25.9	2.22	33.4	16.7	33.4	41.6
-2	56.4	28.2	56.4	26.0	12.8	26.0	2.17	32.2	16.1	32.2	41.6
-3	55.3	27.6	55.3	26.0	12.8	26.0	2.13	31.0	15.5	31.0	41.6
-4	54.1	27.1	54.1	26.0	12.8	26.0	2.08	29.9	14.9	29.9	41.6
-5	53.0	26.5	53.0	26.0	12.8	26.0	2.04	28.7	14.4	28.7	41.6
-6	51.9	26.0	51.9	26.0	12.8	26.0	2.00	27.6	13.8	27.6	41.5
-7	50.8	25.4	50.8	26.0	12.8	26.0	1.95	26.5	13.3	26.5	41.5
-8	49.8	24.9	49.8	26.0	12.8	26.0	1.91	25.5	12.7	25.5	41.5
-9	48.7	24.4	48.7	26.0	12.8	26.0	1.87	24.4	12.2	24.4	41.4
-10	47.7	23.9	47.7	26.1	12.9	26.1	1.83	23.4	11.7	23.4	41.4
-11	46.7	23.4	46.7	26.1	12.9	26.1	1.79	22.4	11.2	22.4	41.3
-12	45.7	22.9	45.7	26.1	12.9	26.1	1.75	21.4	10.7	21.4	41.3
-13	44.8	22.4	44.8	26.1	12.9	26.1	1.71	20.4	10.2	20.4	41.2
-14	43.8	21.9	43.8	26.1	12.9	26.1	1.68	19.4	9.7	19.4	41.1
-15	42.9	21.5	42.9	26.2	12.9	26.2	1.64	18.5	9.2	18.5	41.1

-- pozor: pracovný rozsah nie je zohľadnený v tabuľke

Tch -VY [°C]		W 12 / 7 °C									
Tz -VS [°C]	Qc nom [kW]	Qc min [kW]	Qc max [kW]	Pin nom [kW]	Pin min [kW]	Pin max [kW]	EER kW / kW	Qh nom [kW]	Qh min [kW]	Qh max [kW]	I nom [A]
40	40.2	20.1	40.2	16.7	8.2	16.7	2.41	55.8	27.9	55.8	30.0
39	40.5	20.3	40.5	16.3	8.0	16.3	2.49	55.8	27.9	55.8	29.5
38	40.9	20.4	40.9	15.9	7.8	15.9	2.57	55.7	27.9	55.7	29.0
37	41.2	20.6	41.2	15.5	7.6	15.5	2.66	55.7	27.8	55.7	28.5
36	41.5	20.8	41.5	15.1	7.5	15.1	2.75	55.7	27.8	55.7	28.1
35	41.9	20.9	41.9	14.8	7.3	14.8	2.83	55.7	27.8	55.7	27.6
34	42.2	21.1	42.2	14.4	7.1	14.4	2.93	55.6	27.8	55.6	27.2
33	42.5	21.2	42.5	14.1	6.9	14.1	3.02	55.6	27.8	55.6	26.8
32	42.8	21.4	42.8	13.7	6.8	13.7	3.11	55.6	27.8	55.6	26.4
31	43.1	21.5	43.1	13.4	6.6	13.4	3.21	55.6	27.8	55.6	26.1
30	43.4	21.7	43.4	13.1	6.5	13.1	3.31	55.6	27.8	55.6	25.7
29	43.6	21.8	43.6	12.8	6.3	12.8	3.41	55.6	27.8	55.6	25.4
28	43.9	21.9	43.9	12.5	6.2	12.5	3.52	55.5	27.8	55.5	25.0
27	44.2	22.1	44.2	12.2	6.0	12.2	3.62	55.5	27.8	55.5	24.7
26	44.4	22.2	44.4	11.9	5.9	11.9	3.73	55.5	27.8	55.5	24.4
25	44.7	22.3	44.7	11.6	5.7	11.6	3.84	55.5	27.8	55.5	24.1
24	44.9	22.4	44.9	11.3	5.6	11.3	3.96	55.5	27.7	55.5	23.8
23	45.1	22.6	45.1	11.1	5.5	11.1	4.07	55.5	27.7	55.5	23.6
22	45.3	22.7	45.3	10.8	5.3	10.8	4.19	55.4	27.7	55.4	23.3
21	45.6	22.8	45.6	10.6	5.2	10.6	4.32	55.4	27.7	55.4	23.1
20	45.8	22.9	45.8	10.3	5.1	10.3	4.44	55.4	27.7	55.4	22.8

Tc [°C]		W 23 / 18 °C									
0 [°C]	Qc nom [kW]	Qc min [kW]	Qc max [kW]	Pin nom [kW]	Pin min [kW]	Pin max [kW]	EER kW / kW	Qh nom [kW]	Qh min [kW]	Qh max [kW]	I nom [A]
40	54.8	27.4	54.8	16.7	8.2	16.7	3.28	70.1	35.1	70.2	29.5
39	55.2	27.6	55.2	16.3	8.0	16.3	3.39	70.1	35.1	70.1	29.0
38	55.6	27.8	55.6	15.9	7.8	15.9	3.50	70.2	35.1	70.1	28.5
37	56.0	28.0	56.0	15.5	7.6	15.5	3.61	70.2	35.1	70.1	28.0
36	56.4	28.2	56.4	15.1	7.5	15.1	3.73	70.2	35.1	70.1	27.6
35	56.8	28.4	56.8	14.8	7.3	14.8	3.84	70.2	35.1	70.1	27.1
34	57.1	28.6	57.1	14.4	7.1	14.4	3.96	70.2	35.1	70.1	26.7
33	57.5	28.7	57.5	14.1	6.9	14.1	4.09	70.3	35.1	70.1	26.3
32	57.8	28.9	57.8	13.7	6.8	13.7	4.21	70.3	35.1	70.1	25.9
31	58.2	29.1	58.2	13.4	6.6	13.4	4.34	70.3	35.2	70.1	25.5
30	58.5	29.3	58.5	13.1	6.5	13.1	4.47	70.3	35.2	70.1	25.1
29	58.8	29.4	58.8	12.8	6.3	12.8	4.60	70.3	35.2	70.1	24.8
28	59.2	29.6	59.2	12.5	6.2	12.5	4.74	70.3	35.2	70.2	24.4
27	59.5	29.7	59.5	12.2	6.0	12.2	4.88	70.3	35.2	70.2	24.1
26	59.8	29.9	59.8	11.9	5.9	11.9	5.02	70.3	35.2	70.2	23.8
25	60.0	30.0	60.0	11.6	5.7	11.6	5.17	70.3	35.2	70.2	23.5
24	60.3	30.2	60.3	11.3	5.6	11.3	5.32	70.3	35.2	70.2	23.2
23	60.6	30.3	60.6	11.1	5.5	11.1	5.47	70.3	35.2	70.3	22.9
22	60.8	30.4	60.8	10.8	5.3	10.8	5.63	70.3	35.1	70.3	22.7
21	61.1	30.5	61.1	10.6	5.2	10.6	5.79	70.3	35.1	70.3	22.4
20	61.3	30.7	61.3	10.3	5.1	10.3	5.95	70.2	35.1	70.3	22.2

-- pozor: pracovný rozsah nie je zohľadnený v tabuľke

LEGENDA:

Tz-VS: Teplota zdroja - vstup [°C]

Tv-VY: Teplota vykurovania - výstup [°C]

Tch-VY: Teplota chladenia - výstup [°C]

Qh nom: Nominálny tepelný výkon

Qh min: Minimálny tepelný výkon

Qh max: Maxmálny tepelný výkon

Pin nom: Príkion pri nominálnom tepelnom výkone

Pin min: Príkion pri minimálnom tepelnom výkone

Pin max: Príkion pri maximálnom tepelnom výkone

COP nom: Koeficient účinnosti pri nominálnom tepelnom výkone

Qc nom: Chladiaci výkon / odobrané teplo pri nominálnom tepelnom výkone

Qc min: Chladiaci výkon / odobrané teplo pri minimálnom tepelnom výkone

Qc max: Chladiaci výkon / odobrané teplo pri maximálnom tepelnom výkone

I nom: Prúd pri nominálnom tepelnom výkone

EER: Koeficient účinnosti pri nominálnom chladiacom výkone

Prevádzkové Temp °C limity

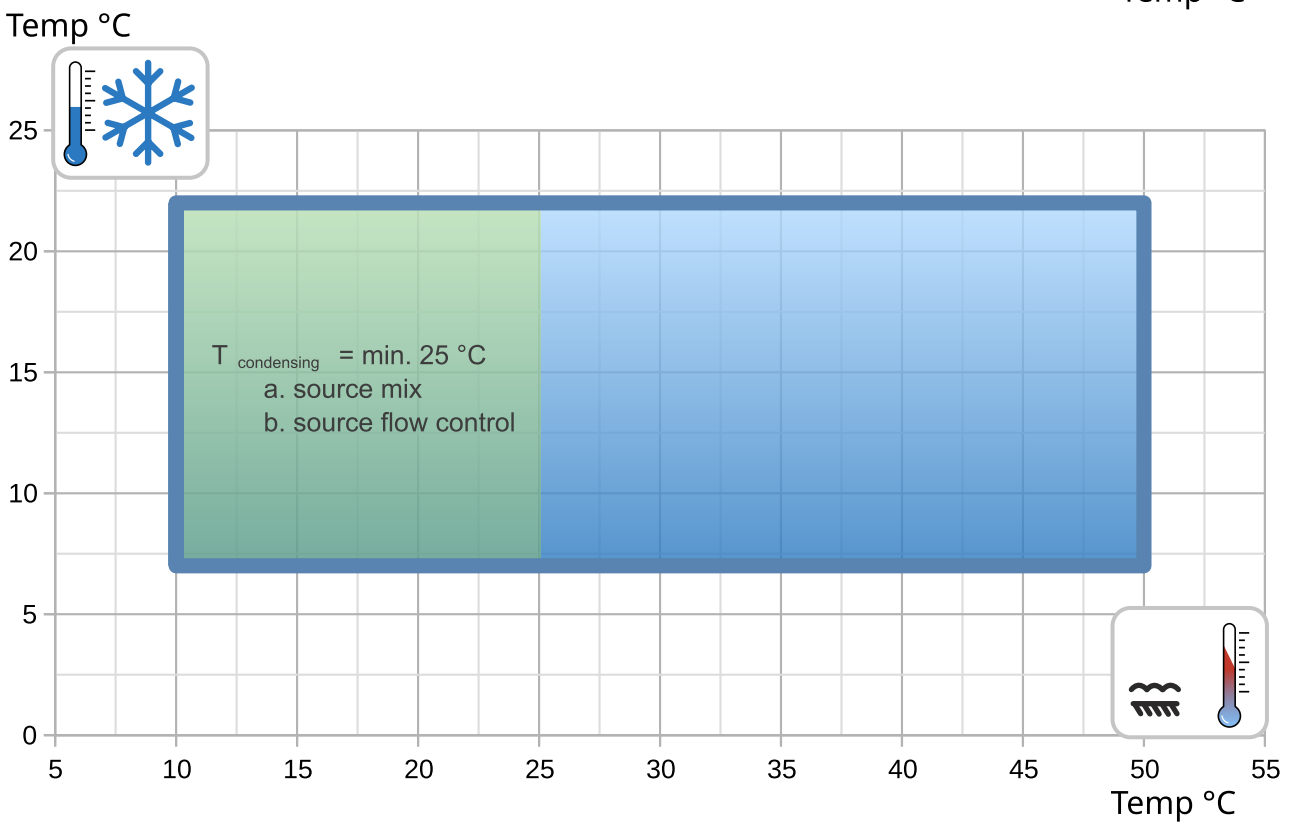
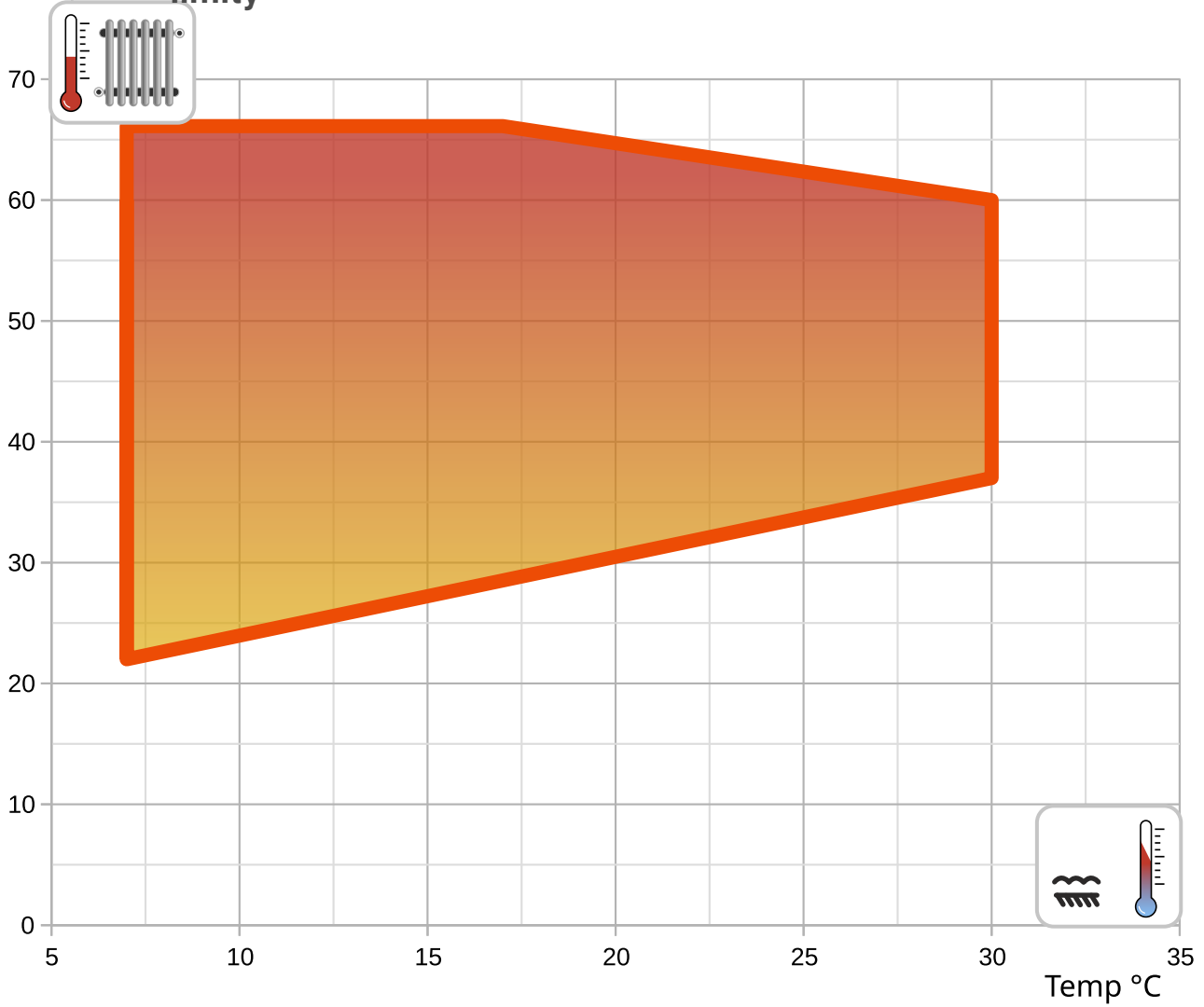

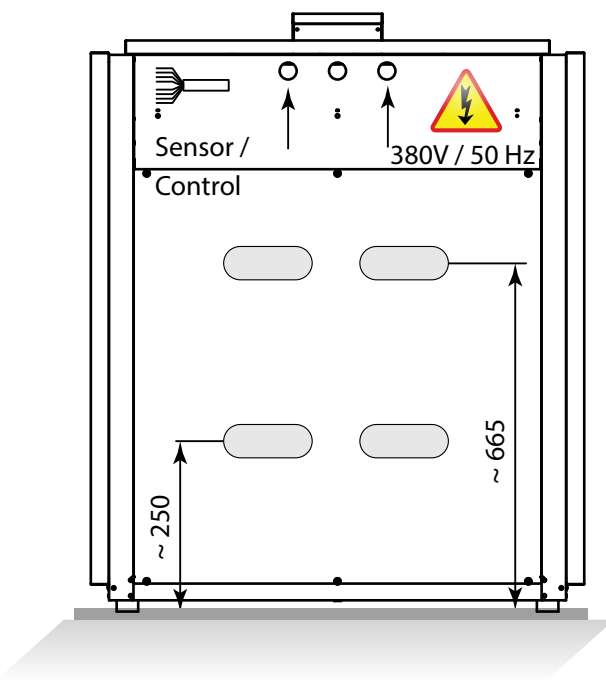
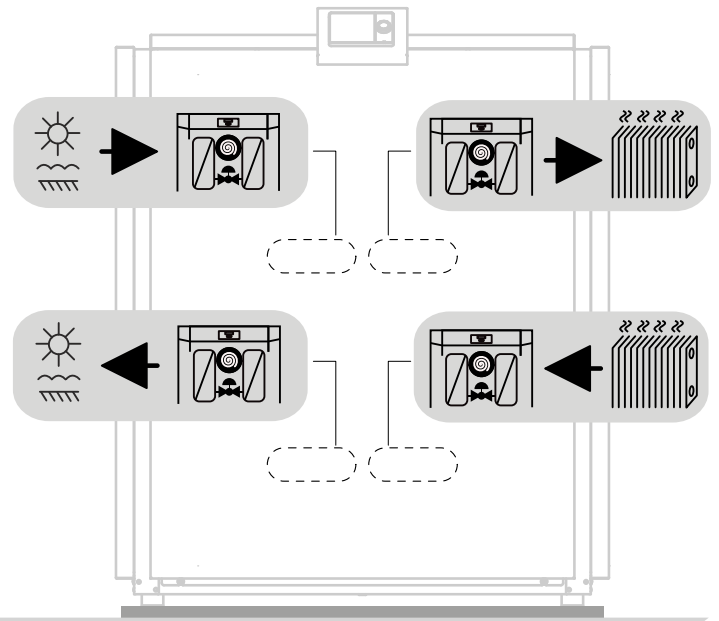
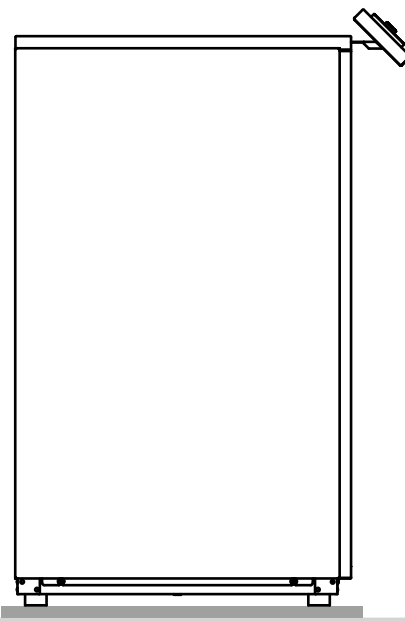

int. code: VN1100

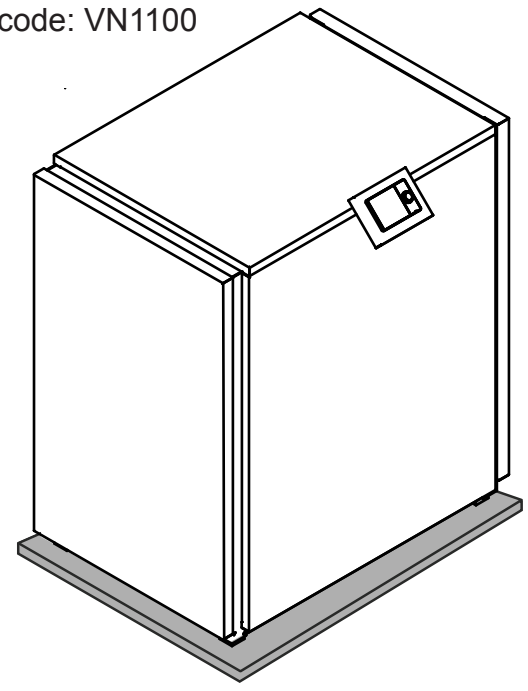

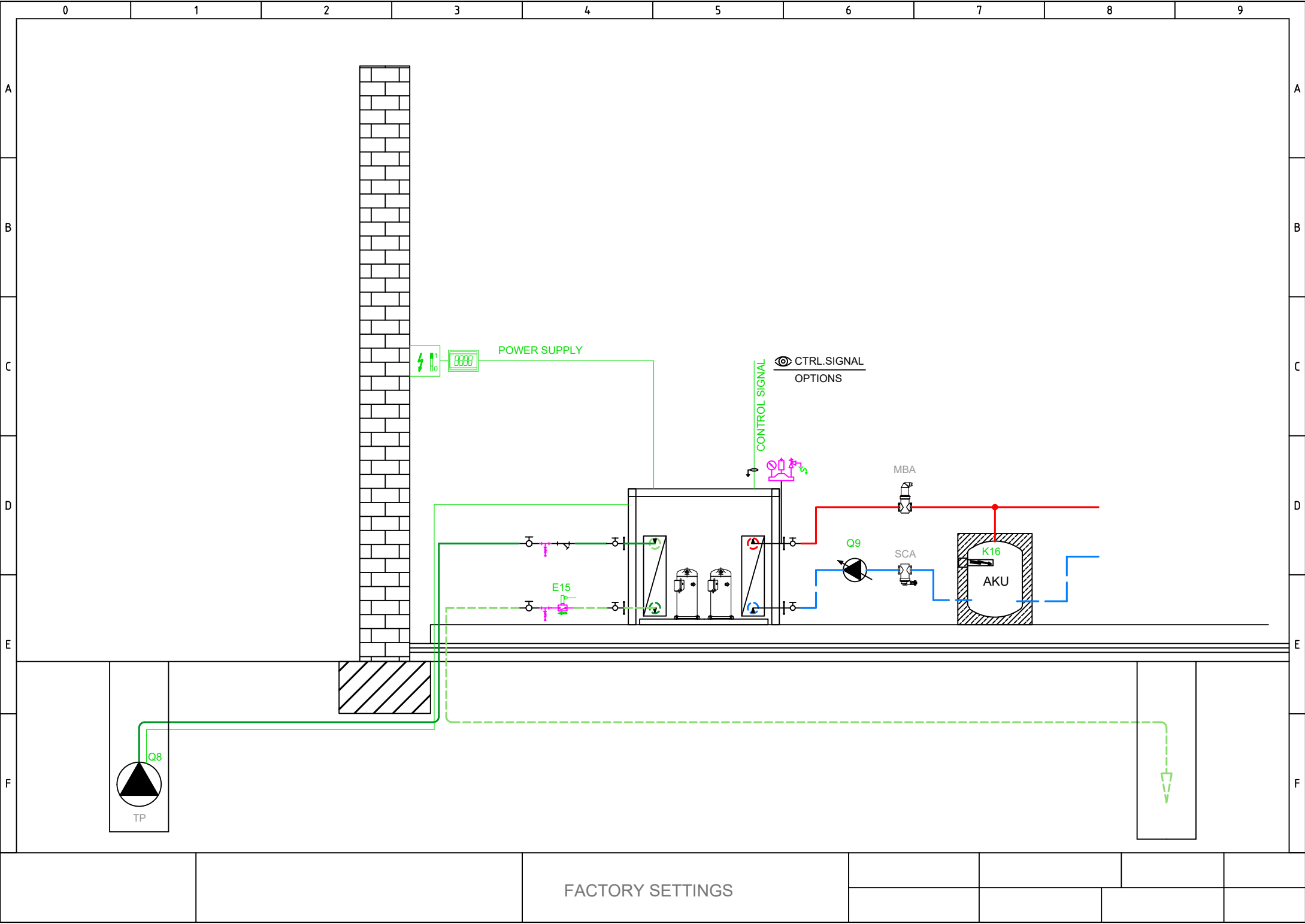

0 1 2 3 4 5 6 7 8 9

A

A

B

B

C

C

D

D

E

E

F

F

POWER SUPPLY

CONTROL SIGNAL
CTRL.SIGNAL
OPTIONS

MBA

Q9

SCA

K16

AKU

E15

Q8

TP

FACTORY SETTINGS



BASIC APPLICATION



OPTIONAL APPLICATION

Total: max 6A
1 x QX...: max 2A

Hlavné napájanie 230V / 50 Hz
Uzemnenie
Nulový vodič

E9	Spínač nízkeho tlaku E9
E10	Spínač vysokého tlaku E10
E15	Spínač prietoku zdroja E15
E24	Spínač prietoku spotreby E24
E6	Blokovanie vys. tarifa el. E6
E12	Preťaženie kompresora 2 E12
E21	Sled fáz E21
E22	Sled fáz E22
E23	Sled fáz E23
E11	Preťaženie kompresora E11
K1	Kompresor I. stupeň K1

Q8 Čerpadlo zdroja Q8

Q9 Čerpadlo kondenzátora Q9

K10 Alarmový výstup K10

K40 Ohrev oleja K40

K81 Ventil výparníka K81

K82 Ventil EVI K82

K2 Kompresor 2. stupeň K2

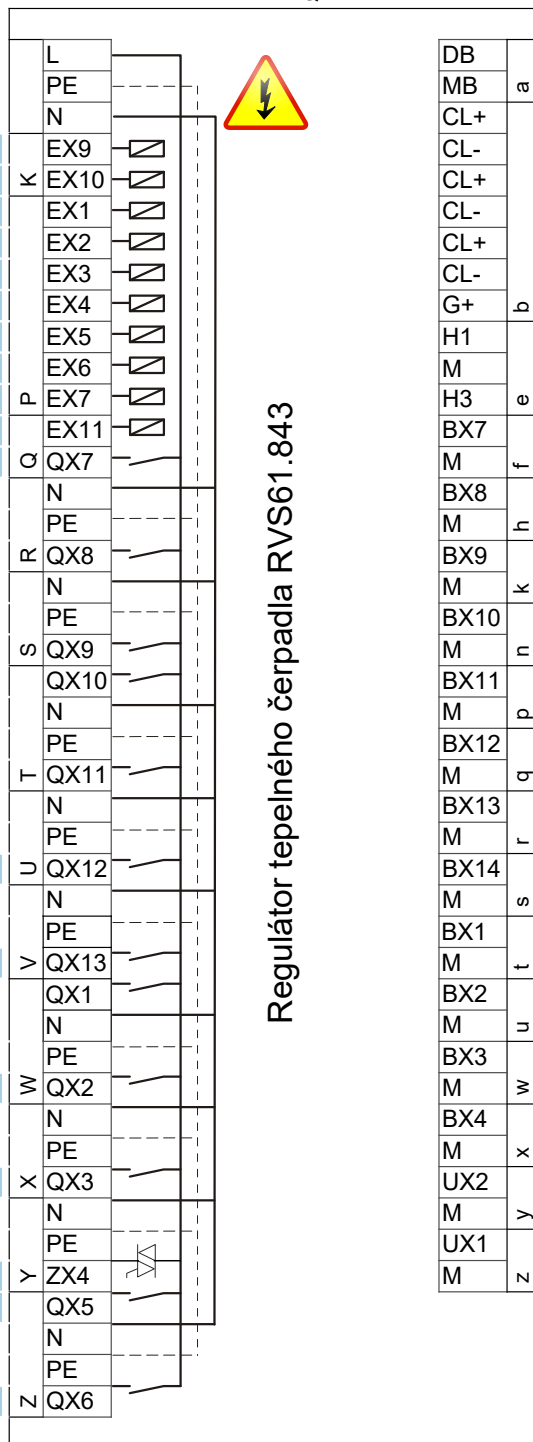

Regulátor tepelného čerpadla RVS61.843

DB	LPB Bus dáta
MB	LPB Bus zem
CL+	Izbový prístroj QAA...
CL-	Izbový prístroj QAA...
CL+	Izbový prístroj QAA... 2.
CL-	Izbový prístroj QAA... 2.
CL+	Izbový prístroj QAA... 3.
CL-	Izbový prístroj QAA... 3.
G+	12V napájanie → von
H1	
M	
H3	Požiadavka spotrebiča VK1
BX7	B81 Snímač horúcich plynov K1 B81
M	
BX8	
M	
BX9	
M	
BX10	B21 Snímač teploty výstupu TČ B21
M	
BX11	
M	
BX12	B71 Snímač teploty spiatocky TČ B71
M	
BX13	B91 Snímač vstupu zdroja B91
M	
BX14	B84 Snímač výstupu zdroja B92/B84
M	
BX1	
M	
BX2	
M	
BX3	B83 Snímač chladiaceho média B83
M	
BX4	B82 Snímač horúcich plynov K2 B82
M	
UX2	Čerpadlo kondenzátora Q9
M	0..10V analógový signál
UX1	Čerpadlo zdroja Q8
M	0..10V analógový signál

- AVS75.390
- AVS75.391
- AVS75.370

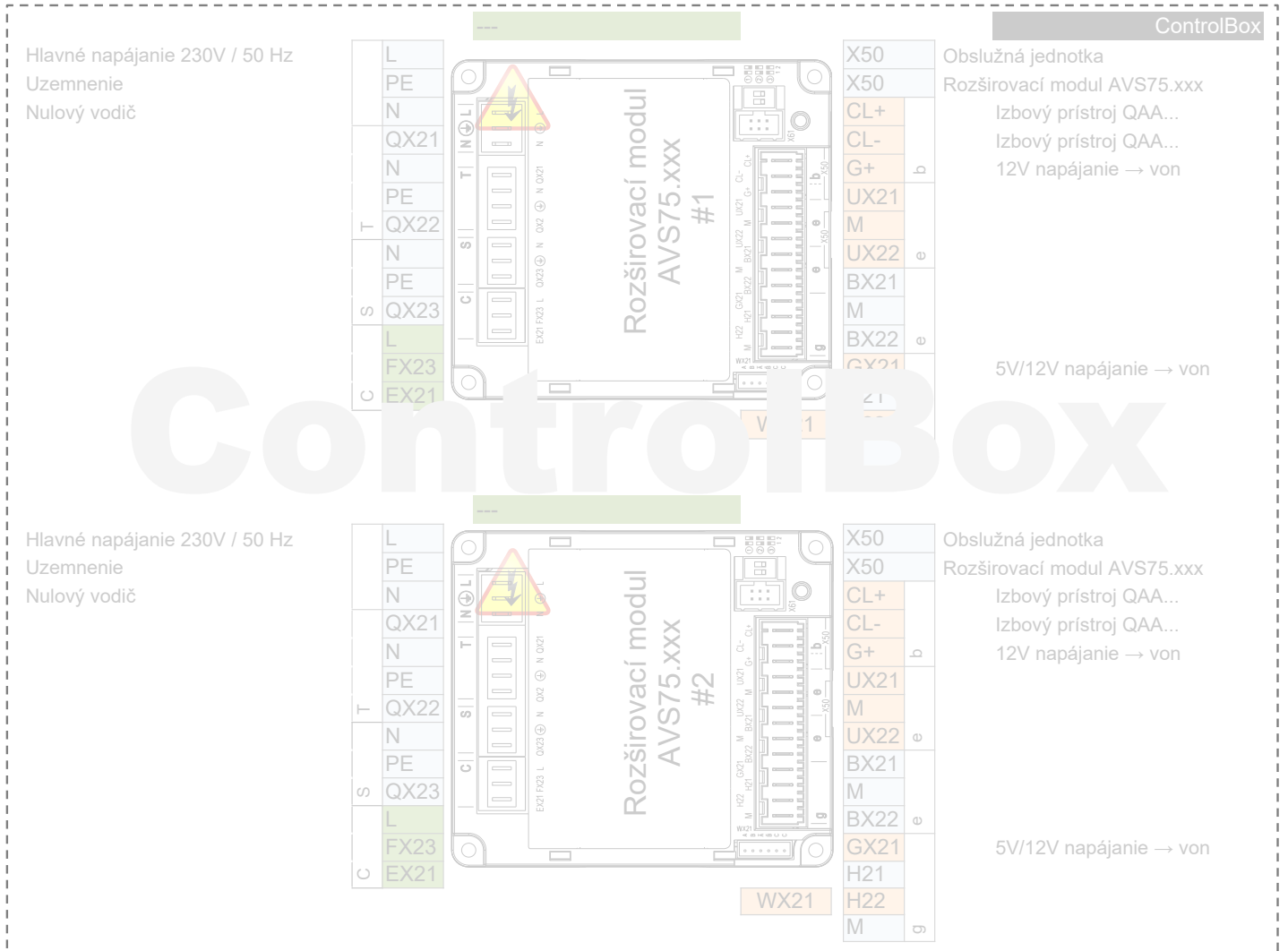

HEAT PUMP

EXTERNAL
INTERNAL



K1

K2

K82

K81

K40

K10

Q8 UX1

Q9 UX2

E11
KRW1
F1K
E11

E12
KRW2
F2K
E12

E6

E24
Q9 ERR
F1S
E24

E15
Q8.ERR
F1Z
E15

E10
E9

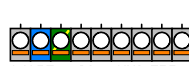

M-K1
MV-EVI-K1
Q1K

M-K1
MV-EVI-K2
Q2K

230V,50Hz
max 6A

0...10V

230V,50Hz
max 6A

0...10V

DO

DI

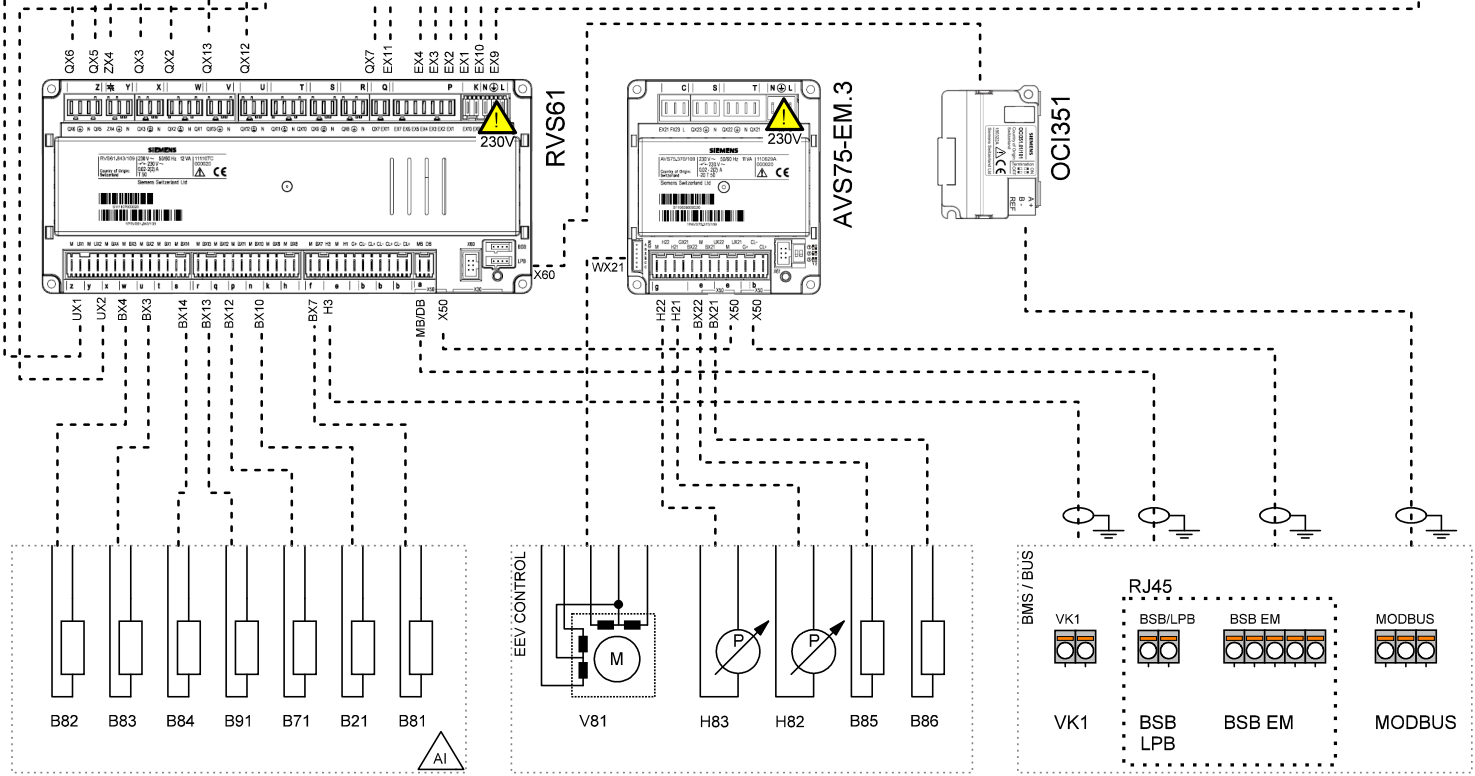
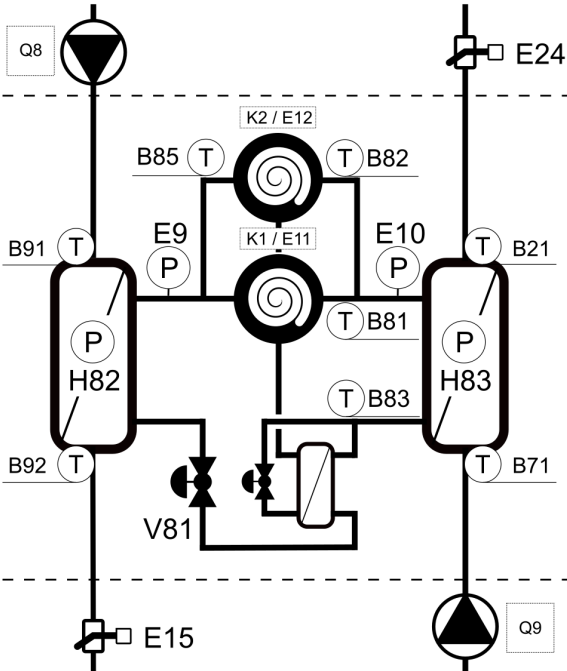

PWR SPLY: 3~ 400V, 50 Hz
CTRL: 1~ 230V, 50 HZ

Company

Title

Version / Note

Number

Created by

Date

Page

TBW-TWW

05/2024

1

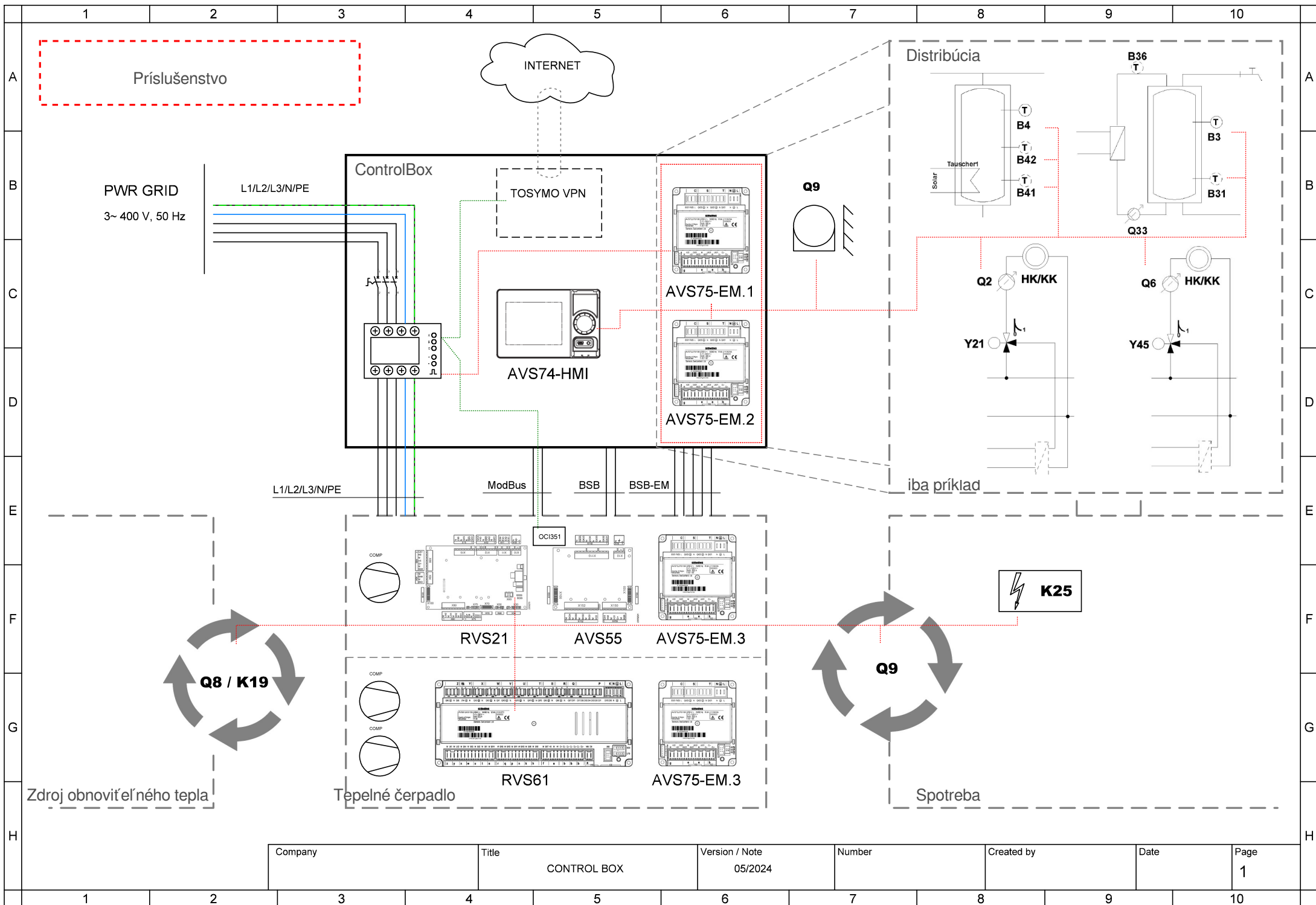

Company	Title	Version / Note	Number	Created by	Date	Page
	CONTROL BOX	05/2024				1



Company	Title	Version / Note	Number	Created by	Date	Page
	CONTROL BOX	05/2024				2

3~ 400 V, 50 Hz

230 V, 50 Hz

L
N
PE

S1

CBL-1
2x0.25

CBL-2
3x0.25

F1S
10A

F1R
6A

SDM72
1

ModBus / Tosymo

ModBus / HP

kWh IMP

L1 L2 L3 N PE

L1 L2 L3 N PE

X0

X1

S

F1S
10A

F1R
6A

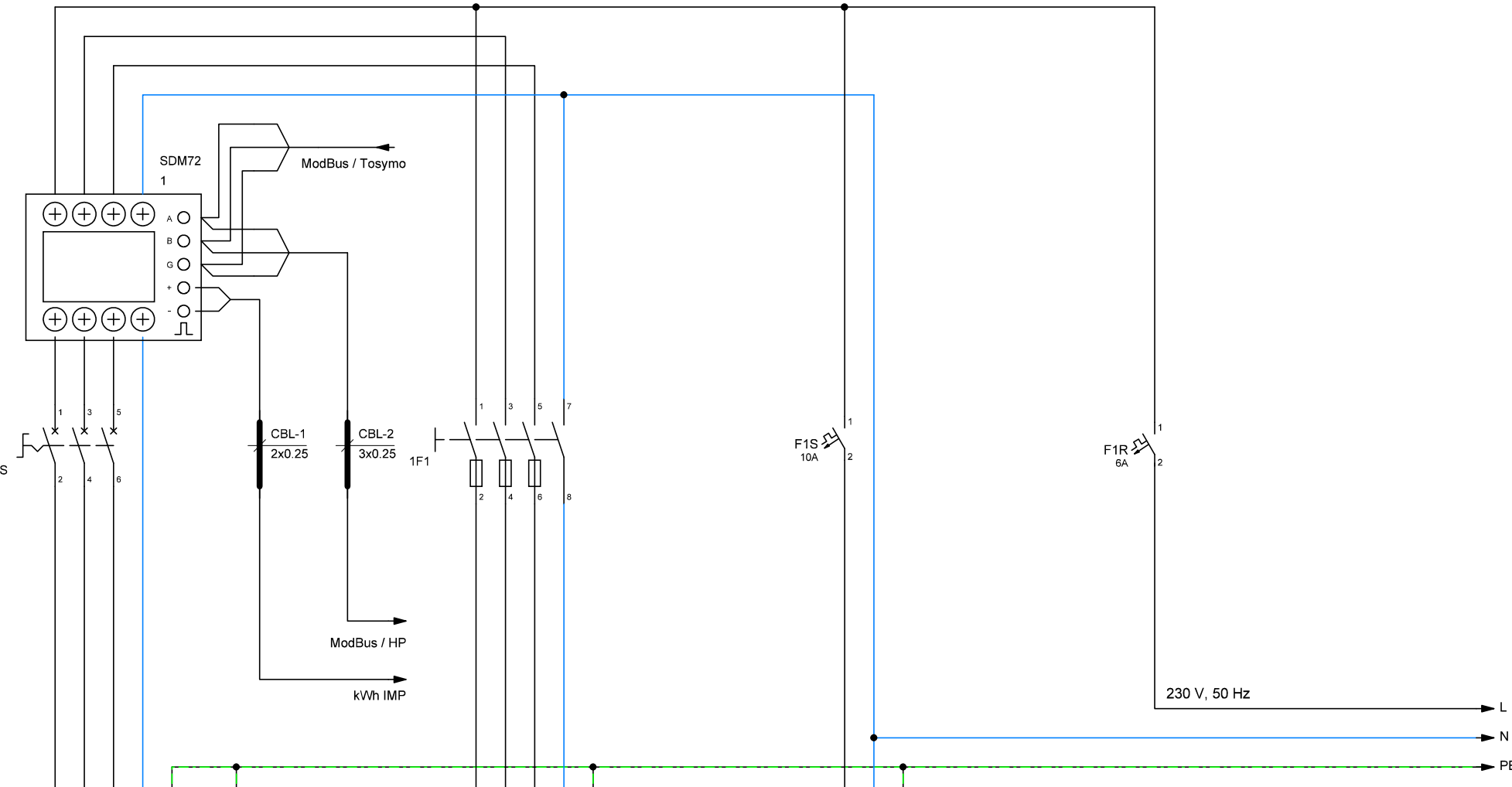
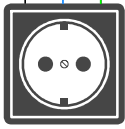
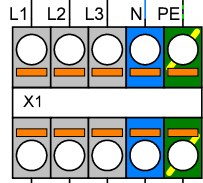
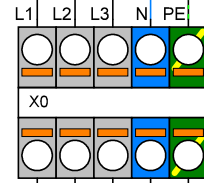
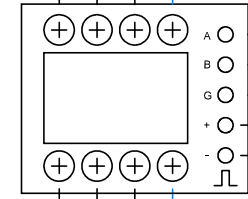
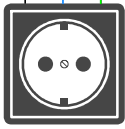

1	2	3	4	5	6	7	8	9	10
A	B	C	D	E	F	G	H		
1	2	3	4	5	6	7	8	9	10



Company	Title	Version / Note	Number	Created by	Date	Page
	CONTROL BOX	05/2024				3



Company	Title	Version / Note	Number	Created by	Date	Page
	CONTROL BOX	05/2024				4



- AVS75.390
- AVS75.391
- AVS75.370

- AVS75.370**
 Hlavné napájanie 230V / 50 Hz
 Uzemnenie
 Nulový vodič
- Y1** Zmiešavací ventil otváranie
 - Y2** Zmiešavací ventil zatváranie
 - Q2** Čerpadlo vyk. okruhu 1 Q2
 - L** Fáza 230V
 - E61** Smart Grid E61

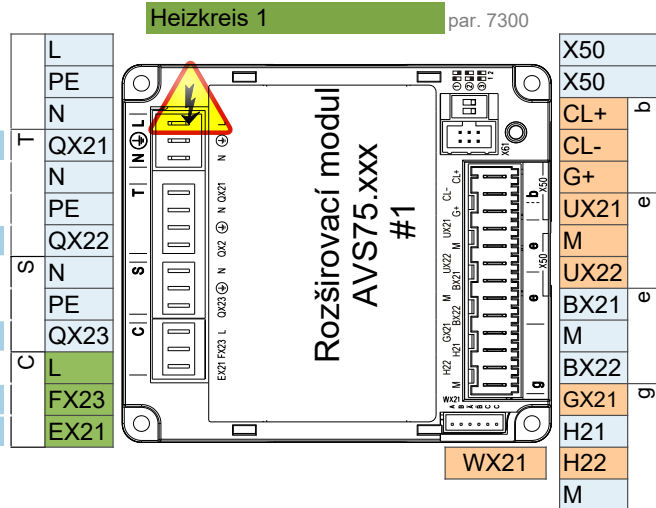

- Rozšiřovací modul AVS75.xxx
 Izbový prístroj QAA...
 Izbový prístroj QAA...
- B1** Snímač prietoku 1
 - Čítanie pulzov**

- AVS75.370**
 Hlavné napájanie 230V / 50 Hz
 Uzemnenie
 Nulový vodič
- Q3** Servopohon TUV Q3
 - K6** El. výhrevná vložka TUV K6
 - Q6** Čerpadlo vyk. okruhu 2 Q6
 - L** Fáza 230V
 - E62** Smart Grid E62

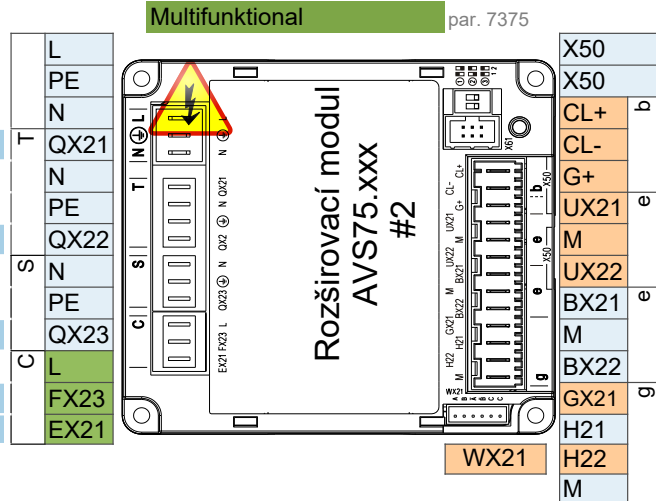

- Obslužná jednotka
 Rozšiřovací modul AVS75.xxx
 Izbový prístroj QAA...
 Izbový prístroj QAA...
- B3** Snímač TUV B3
 - B4** Snímač AKU zásobníka B4

- Hlavné napájanie 230V / 50 Hz
 Uzemnenie
 Nulový vodič

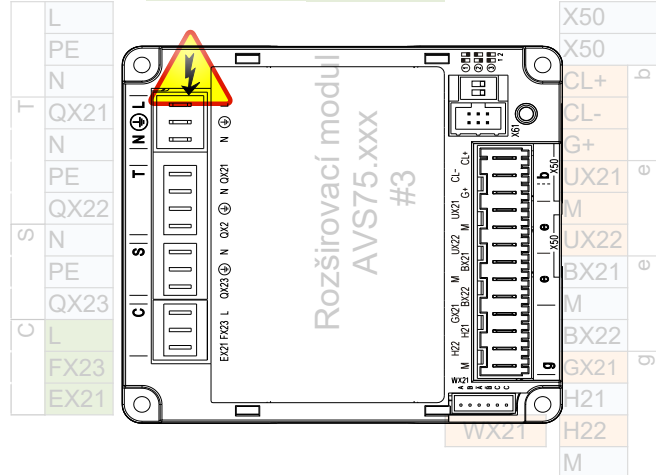

- Obslužná jednotka
 Rozšiřovací modul AVS75.xxx
 Izbový prístroj QAA...
 Izbový prístroj QAA...

Pozor: Rozšiřovací modul 3 je v tepelnom čerpadle

1 ControlBox

ControlBox s dvoma zabudovanými rozširujúcimi modulmi umožňuje početné možnosti ovládania aplikácie na strane spotrebiča za tepelným čerpadlom. Viac informácií nájdete v schéme ControlBoxu a v hárku s aplikačnými schémami.

2 Fixná žiadaná teplota výstupu - Zap / Vyp bezpotenciálny kontakt

2-vodičový tienený kábel 2 x 0,5 mm² - Nastavená hodnota = 45 °C (upraviteľné parametrom 1859)

Pripojovacia svorka - pozri schému zapojenia

3 Analógová regulácia žiadanej teploty výstupu 0..10V

2-vodičový tienený kábel 2 x 0,5 mm² - Nastavená hodnota: 0V = 16°C ~ 10V = 60°C (možnosť úpravy v nastavení parametrov)

Pripojovacia svorka - pozri schému zapojenia

4 ModBus RTU komunikačný príkaz

3 žilový tienený kábel min. 3 x 0,25 mm²

Pre tabuľku mapovania ModBus kontaktujte technickú podporu

5 MQTT IoT komunikačný protokol

Pre viac informácií kontaktujte technickú podporu