

Grundlegende Leistungsdaten - WAMAK AiWa 11 EVI H In

Heizen - EN 14511		
Wärmeleistung [kW]	A7 / W35	12.4
	A2 / W35	10.6
	A-7 / W34	8.8
Leistungsaufnahme [kW]	A7 / W35	2.5
	A2 / W35	2.6
	A-7 / W34	2.5
Leistungszahl Heizen [COP]	A7 / W35	4.85
	A2 / W35	4.12
	A-7 / W34	3.49
Jahreszeitbedingte Raumheizungs-Energieeffizienz - SCOP EN 14825		
Klimazone Durchschnitt / Niedrigtemp. [35°C]	SCOP	4.77
	η [%]	190.9
	Label	A+++
	Qhe [kWh]	4168.8
	Pdesignh [kW]	9.9
	Tbivalent [°C]	-7
Kühlung		
Kühlleistung - [kW]	A35 / W23-18	11.5
	A25 / W23-18	12.3
	A35 / W12-7	8.6
	A25 / W12-7	8.6
Jahreszeitbedingte Raumkühlungs-Energieeffizienz - SEER EN 14825		
[W 23 / 18°C]	SEER	4.69
	Qce [kWh]	5160.0
	η_c [%]	187.5
Schall EN 12102		
Schalleistungspegel - Lw	dB(A)	55.9
Schalldruckpegel - Lp	1 m dB(A)	47.9
	5 m dB(A)	33.9
	10 m dB(A)	27.9
Mechanische und Betriebs-Informationen		
Verdichterbauart (3~ 400/50)	SCROLL / 1 /	Ein/Aus
Kältemittel	R410A (GWP - 2088)	5 kg
Einsatzgrenze Heizungswasser - (min / max) [°C]		25 / 65
Einsatzgrenze Wärmequelle - (min / max) [°C]		-22 / 40
Gewicht		270 kg

Wichtigste technische Daten - WAMAK AiWa 11 EVI H In

Gehäuse Bezeichnung		AiWa-I		Daten von Wärmeabgabe		
Grundlegende Abmessungen	Hohe [mm]	1760		Einsatzgrenze Heizungswasser	MAX [°C] 65	
	Breite [mm]	920			MIN [°C] 25	
	Länge [mm]	660		genauer siehe Betriebsgrenzendiagramm		
Gewicht [kg]	270		Kondensator	Anschlussdimension	1 "	
Gehäuse Farbe	Grau			Bauart	BPHE	
Gehäuse IP Klasse	IP44			Anzahl	1	
				Material	AISI 316	
Kältekreis						
Verdichter	Bauart	Scroll		Maximaler Überdruck - Kältemittel [bar]	45	
	Leistungstufen	1		Maximaler Überdruck - Wasser [bar]	6	
	Ein/Aus			Prüfdruck [bar]	70	
	Leistungsfaktor Cosφ	0.79		Wärmeträger	Wasser	
	Wicklungswiderstand	3.20 Ohm		Volumenstrom @ dT 5K (nom) - Wasser [m3/h]	2.13	
Kältemittel		R410A		Interne Druckdifferenz - Wasser [kPa]	12	
	Menge	5 kg		ECM Kondensator-pumpe	UPM3 25-75	
	GWP	2088		Durchflusssensor Abgabe - analog	0..10V	
	Sicherheitsklasse	A1		Temperaturdifferenz @ 35°C (nom)	5 K	
Kältemittelöl	POE RL32-3MAF			@ 55°C	8 K	
	Ölmenge	1.25 L		@ 65°C	10 K	
Maximaler Hochdruck - Kältemittel [bar]		45		Daten von Erneuerbarer Energiequelle		
	PED Klasse	1		Einsatzgrenze Wärmequelle	MIN [°C] -22	
EVI - Dampfeinspritzung mit Economiser					MAX [°C] 40	
APS System mit Flüssigkeitsunterkühlung				genauer siehe Betriebsgrenzendiagramm		
Reversibler Betrieb (Kühlung)				Verdampfer	Anschlussdimension	700mm x 700mm "
Reversible Abtauung mit Heissgas					Bauart	Cu-coil /Al-fin
					Anzahl	1
					Material	Cu/Al
Daten von Elektroanschluss						
Einspeisung [#~ V/Hz]			3~ 400/50		Maximaler Überdruck - Kältemittel [bar]	28
Strom	Nominal [A]	4.28		Wärmeträger	Luft	
	Maximal [A]	9.20		Volumenstrom - Luft [m3/h]	3930	
	Start [A]	11.55		Interne Druckdifferenz - Luft [kPa]	0.02	
Sanftanlasser			MCI 12		Temperaturdifferenz - Luft	7 K
Hauptsicherung			C20		Anzahl von Ventilatoren	1
Steuerungssystem						
Hauptregler	SIEMENS	RVS 21	AVS 55.199	Ventilatordurchmesser [mm]	630	
Erweiterungsmo dul	AVS75.3xx	AVS75.3xx	AVS75.372			
Bus Clip-In		LPB OCI347	Modbus OCI353			
Online-Verbindung		Web server OZW672	ToSyMo			
EEV Regelung			1 - EEV H/C			

*** mit Zubehör

WAMAK AiWa 11 EVI H In

ErP (EU) No 811/2013: Technische Parameter für Wärmepumpen-Raumheizgeräte

Modell	AiWa 11 EVI H In
Luft-Wasser-Wärmepumpe	ja
Sole/Wasser-Wärmepumpe	nein
Wasser/Wasser-Wärmepumpe	nein
Niedertemperatur-Wärmepumpe	nein
Ausgestattet mit einer Zusatzheizung	nein
Wärmepumpen-Kombi-Heizgerät	nein
Temperaturanwendung	niedrig (35 °C - 30 °C)
Klimaverhältnisse	durchschnittlich

Angabe	Symbol	Wert	Ein.	Angabe	Symbol	Wert	Ein.
Nennwärmeleistung bei Tdesignh	Prated	9.9	kW	Jahreszeitbedingte Raumheizungs-Energieeffizienz	η_s	190.9	%
Ausgewiesene Heizleistung für Teillast bei einer Innentemperatur von 20 °C und einer Außentemperatur von Tj				Deklarierte Leistungszahl oder Primärenergiekennzahl für Teillast bei einer Innentemperatur von 20 °C und einer Außentemperatur von Tj			
Tj = -7 °C	Pdh	8.8	kW	Tj = -7 °C	COPd	3.49	-
Tj = +2 °C	Pdh	10.6	kW	Tj = +2 °C	COPd	4.7	-
Tj = +7 °C	Pdh	12.3	kW	Tj = +7 °C	COPd	6.1	-
Tj = +12 °C	Pdh	14.3	kW	Tj = +12 °C	COPd	8.2	-
Tj = bivalente Temperatur	Pdh	8.5	kW	Tj = bivalente Temperatur	COPd	3.3	-
Tj = Betriebsgrenztemperatur	Pdh	6.2	kW	Tj = Betriebsgrenztemperatur	COPd	2.4	-
Bivalente Temperatur	Tbiv	-7	°C	Tj = Betriebsgrenztemperatur	TOL	-22	°C
Stromverbrauch in anderen Modi als dem aktiven Modus				Betriebsgrenztemperatur des Heizwassers	WTOL	65	°C
Aus-Zustand	Poff	0.010	kW	Zusatzheizung			
Thermostat-Aus-Modus	Pto	0.010	kW	Nennwärmeleistung	Psup	4.4	kW
Standby-Betrieb	Psb	0.010	kW	Art der Energiezufuhr			
Betriebsart Kurbelwannenheizung	Pck	0.020	kW	elektrisch			
Sonstige Angaben				Für Luft/Wasser-Wärmepumpen: - 3930 m ³ /h			
Leistungsregelung				Nennluftvolumenstrom, Außenbereich			
Schalleistungspegel				Für Wasser- oder Sole/Wasser-Wärmepumpen: Nenndurchfluss der Sole oder des Wassers, Wärmetauscher im Freien			
in Innenräumen	Lwa	56	dB	-			
im Freien	Lwa	---	dB	---			
Jährlicher Energieverbrauch	Q _{HE}	4168.8	kWh				

Angaben zum Kontakt: WAMAK, s.r.o., Orovnica 252, 96652, Orovnica, Slovakia, info@wamak.sk

WAMAK AiWa 11 EVI H In

ErP (EU) No 811/2013: Technische Parameter für Wärmepumpen-Raumheizgeräte

Modell	AiWa 11 EVI H In
Luft-Wasser-Wärmepumpe	ja
Sole/Wasser-Wärmepumpe	nein
Wasser/Wasser-Wärmepumpe	nein
Niedertemperatur-Wärmepumpe	nein
Ausgestattet mit einer Zusatzheizung	nein
Wärmepumpen-Kombi-Heizgerät	nein
Temperaturanwendung	mittel (55 °C - 47 °C)
Klimaverhältnisse	durchschnittlich

Angabe	Symbol	Wert	Ein.	Angabe	Symbol	Wert	Ein.
Nennwärmeleistung bei Tdesignh	Prated	10.5	kW	Jahreszeitbedingte Raumheizungs-Energieeffizienz	η_s	143.7	%
Ausgewiesene Heizleistung für Teillast bei einer Innentemperatur von 20 °C und einer Außentemperatur von Tj				Deklarierte Leistungszahl oder Primärenergiekennzahl für Teillast bei einer Innentemperatur von 20 °C und einer Außentemperatur von Tj			
Tj = -7 °C	Pdh	9.2	kW	Tj = -7 °C	COPd	2.32	-
Tj = +2 °C	Pdh	10.7	kW	Tj = +2 °C	COPd	3.5	-
Tj = +7 °C	Pdh	12.4	kW	Tj = +7 °C	COPd	4.7	-
Tj = +12 °C	Pdh	14.3	kW	Tj = +12 °C	COPd	6.7	-
Tj = bivalente Temperatur	Pdh	9.0	kW	Tj = bivalente Temperatur	COPd	2.1	-
Tj = Betriebsgrenztemperatur	Pdh	7.1	kW	Tj = Betriebsgrenztemperatur	COPd	1.7	-
Bivalente Temperatur	Tbiv	-7	°C	Tj = Betriebsgrenztemperatur	TOL	-22	°C
Stromverbrauch in anderen Modi als dem aktiven Modus				Betriebsgrenztemperatur des Heizwassers	WTOL	65	°C
Aus-Zustand	Poff	0.010	kW	Zusatzheizung			
Thermostat-Aus-Modus	Pto	0.010	kW	Nennwärmeleistung	Psup	4.4	kW
Standby-Betrieb	Psb	0.010	kW	Art der Energiezufuhr	elektrisch		
Betriebsart Kurbelwannenheizung	Pck	0.020	kW	Sonstige Angaben			
Leistungsregelung				fest			
Schalleistungspegel				Für Luft/Wasser-Wärmepumpen: Nennluftvolumenstrom, Außenbereich	-	3930	m ³ /h
in Innenräumen	Lwa	56	dB	Für Wasser- oder Sole/Wasser-Wärmepumpen: Nenndurchfluss der Sole oder des Wassers, Wärmetauscher im Freien	-	---	m ³ /h
im Freien	Lwa	---	dB				
Jährlicher Energieverbrauch	Q _{HE}	5922.0	kWh				

Angaben zum Kontakt: WAMAK, s.r.o., Orovnica 252, 96652, Orovnica, Slovakia, info@wamak.sk



ENERG Y IIA
 енергия - ενεργεια IE IA



AiWa 11 EVI H In



55 °C

35 °C

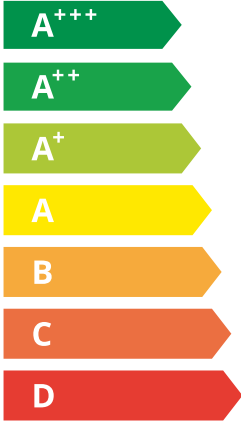

56 dB

--- dB

■ 12	■ 11
■ 11	■ 10
■ 11	■ 10
kW	kW

2019

811/2013

AiWa 11 EVI H In

ErP Data

	55 °C	35 °C
Energy class	A++	A+++
η [%]	143.7	190.9
P_{rated} [kW]	11	10
Q_{HE} [kWh/y]	5922	4169
SCOP [-]	3.59	4.77
$T_{bivalent}$ [°C]	-7	-7

CONTROLLER



+ QAA55/75 class VII 3.5% ↓
 - QAA55/75 class III 1.5% ↓

Heizleistung Daten

Version: v2024.010-AW

Klimazone Durchschnitt / Niedrigtemp. [35°C]

ZHI11K1P-TFM_R410A_1_AW

Betriebsbedingungen		Qh	P	COP
1	A7 / W30-35	12.4	2.5	4.85
2	A2 / W35	10.6	2.6	4.12
3	A-22 / W35	6.2	2.5	2.45
A	A-7 / W34	8.8	2.5	3.49
B	A2 / W30	10.6	2.3	4.66
C	A7 / W27	12.3	2.0	6.05
D	A12 / W24	14.3	1.7	8.24
E	A-10 / W35	8.5	2.6	3.29
F	A-7 / W34	8.8	2.5	3.49

SCOP DATA EN 14825:2018	
Klimazone Durchschnitt / Niedrigtemp. [35°C]	
SCOPon	4.91
SCOPnet	4.95
SCOP	4.77
η [%]	190.93
Label	A+++
Qh [kWh]	4168.78
Pdesignh [kW]	9.9
Tbivalent [°C]	-7.00

Klimazone Durchschnitt / Mitteltemp. [55°C]

Betriebsbedingungen		Qh	P	COP
1	A7 / W47-55	12.3	4.3	2.88
2	A2 / W55	10.9	4.3	2.53
3	A-22 / W55	7.1	4.0	1.66
A	A-7 / W52	9.2	4.0	2.32
B	A2 / W42	10.7	3.1	3.46
C	A7 / W36	12.4	2.6	4.72
D	A12 / W30	14.3	2.1	6.75
E	A-10 / W55	9.0	4.3	2.11
F	A-7 / W55	9.3	4.3	2.17

SCOP DATA EN 14825:2018	
Klimazone Durchschnitt / Mitteltemp. [55°C]	
SCOPon	3.66
SCOPnet	3.69
SCOP	3.59
η [%]	143.70
Label	A++
Qh [kWh]	5921.98
Pdesignh [kW]	10.5
Tbivalent [°C]	-7.00

Kühlleistung Daten

Niedrigtemperatur Kühlung W 12 / 7°C

Betriebsbedingungen		Qc	P	EER
A	A35 / W12-7	8.6	3.2	2.71
B	A30 / W12-7	8.9	2.8	3.19
C	A25 / W12-7	9.2	2.4	3.75
D	A20 / W12-7	9.4	2.1	4.40

SEER DATA EN 14825:2018 [W 12 / 7°C]	
SEERon	3.64
SEER	3.52
Qc [kWh]	1784.23
η [%]	140.89

Flächenkühlung W 23 / 18°C

Betriebsbedingungen		Qc	P	EER
A	A35 / W23-18	11.5	3.2	3.65
B	A30 / W23-18	11.9	2.5	4.30
C	A25 / W23-18	12.3	2.2	5.05
D	A20 / W23-18	12.7	1.8	5.92

SEER DATA EN 14825:2018 [W 23 / 18°C]	
SEERon	4.90
SEER	4.69
Qc [kWh]	1325.59
η [%]	187.55

Leistungslinien - Heizen

- Qh-nom-35 — Qh-min-35 - - - Qh-max-65 — Qh-nom-45 — Qh-nom-55
- Qh-nom-65 — Pratedh-35 — Pratedh-55

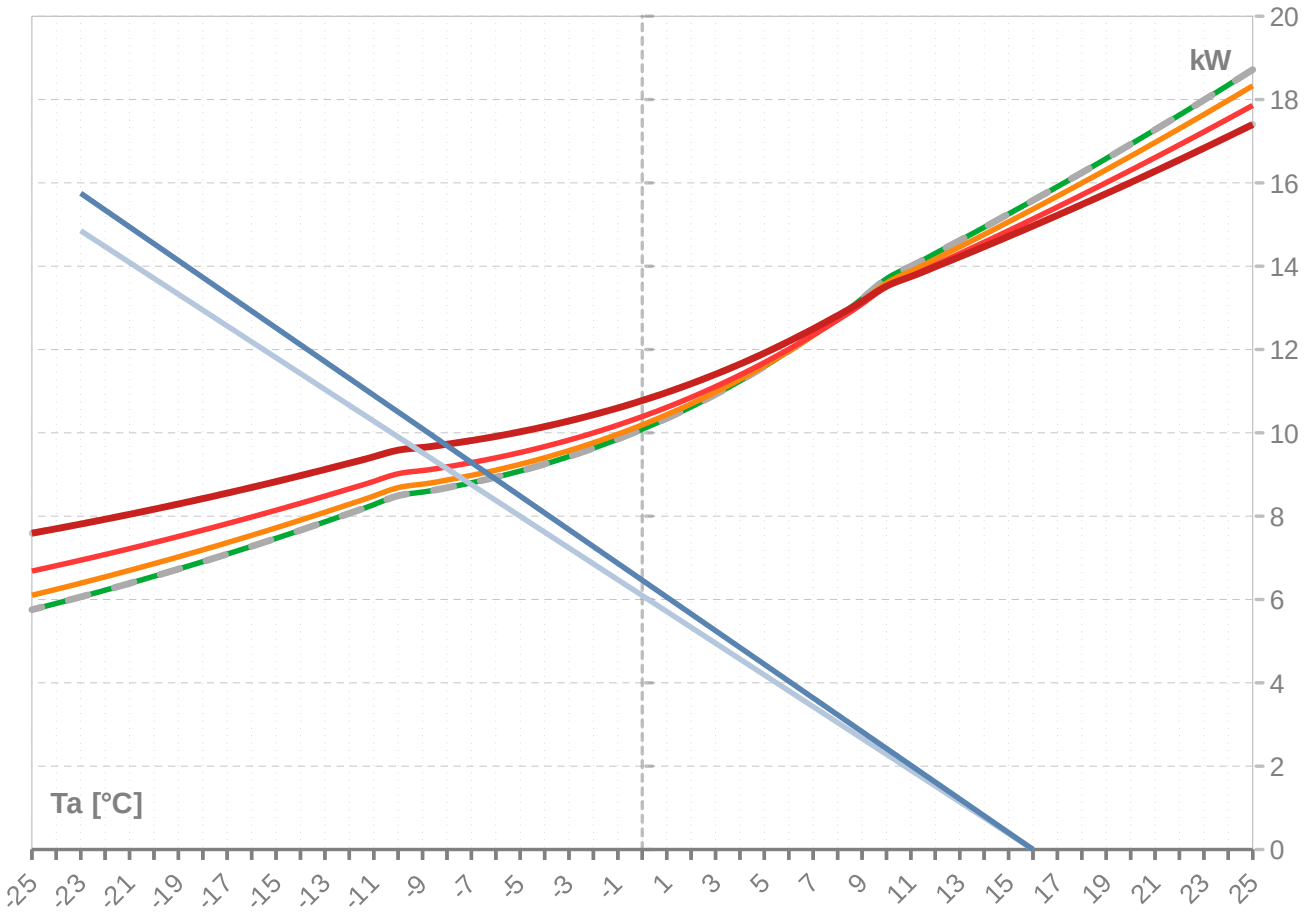

Leistungslinien - Kühlen

- Pratedc — Qc-12/7 — Qc-23/18

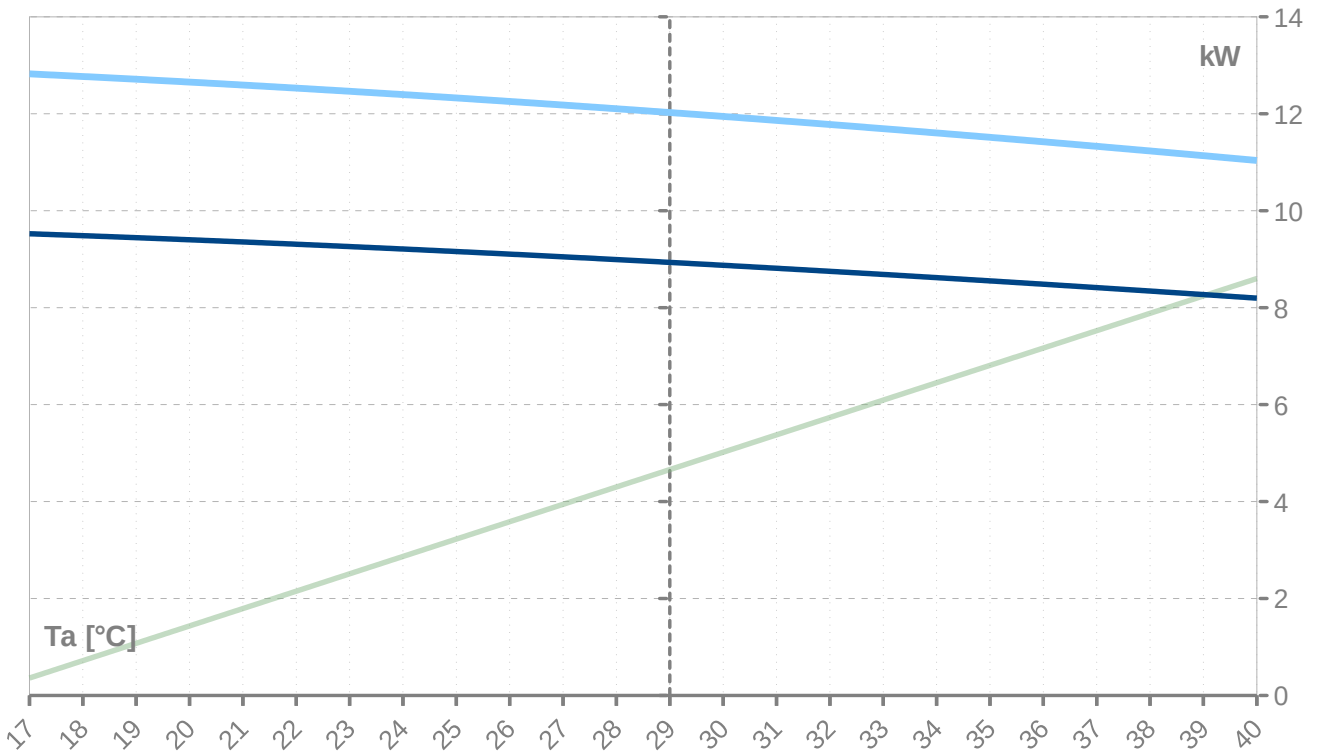

Th [°C]		35 °C								
Ta [°C]	Qh nom [kW]	Qh min [kW]	Qh max [kW]	Pin nom [kW]	Pin-min [kW]	Pin-max [kW]	COP kW / kW	I nom [A]	I min [A]	I max [A]
25	15.9	15.9		2.4	2.4		6.68	4.1	4.1	
24	15.9	15.9		2.4	2.4		6.68	4.1	4.1	
23	15.9	15.9		2.4	2.4		6.68	4.1	4.1	
22	15.9	15.9		2.4	2.4		6.68	4.1	4.1	
21	15.9	15.9		2.4	2.4		6.68	4.1	4.1	
20	15.9	15.9		2.4	2.4		6.68	4.1	4.1	
19	15.9	15.9		2.4	2.4		6.68	4.1	4.1	
18	15.9	15.9		2.4	2.4		6.68	4.1	4.1	
17	15.9	15.9		2.4	2.4		6.68	4.1	4.1	
16	15.6	15.6	15.6	2.4	2.4	2.4	6.49	4.2	4.2	4.2
15	15.3	15.3	15.3	2.4	2.4	2.4	6.30	4.2	4.2	4.2
14	14.9	14.9	14.9	2.4	2.4	2.4	6.12	4.2	4.2	4.2
13	14.6	14.6	14.6	2.5	2.5	2.5	5.95	4.2	4.2	4.2
12	14.3	14.3	14.3	2.5	2.5	2.5	5.79	4.2	4.2	4.2
11	14.0	14.0	14.0	2.5	2.5	2.5	5.63	4.3	4.3	4.3
10	13.7	13.7	13.7	2.5	2.5	2.5	5.48	4.3	4.3	4.3
9	13.2	13.2	13.2	2.5	2.5	2.5	5.25	4.3	4.3	4.3
8	12.8	12.8	12.8	2.5	2.5	2.5	5.04	4.3	4.3	4.3
7	12.4	12.4	12.4	2.5	2.5	2.5	4.85	4.3	4.3	4.3
6	12.0	12.0	12.0	2.6	2.6	2.6	4.68	4.3	4.3	4.3
5	11.6	11.6	11.6	2.6	2.6	2.6	4.52	4.3	4.3	4.3
4	11.2	11.2	11.2	2.6	2.6	2.6	4.37	4.4	4.4	4.4
3	10.9	10.9	10.9	2.6	2.6	2.6	4.24	4.4	4.4	4.4
2	10.6	10.6	10.6	2.6	2.6	2.6	4.12	4.4	4.4	4.4
1	10.3	10.3	10.3	2.6	2.6	2.6	4.00	4.4	4.4	4.4
0	10.1	10.1	10.1	2.6	2.6	2.6	3.90	4.4	4.4	4.4
-1	9.8	9.8	9.8	2.6	2.6	2.6	3.81	4.4	4.4	4.4
-2	9.6	9.6	9.6	2.6	2.6	2.6	3.72	4.4	4.4	4.4
-3	9.4	9.4	9.4	2.6	2.6	2.6	3.65	4.4	4.4	4.4
-4	9.2	9.2	9.2	2.6	2.6	2.6	3.58	4.4	4.4	4.4
-5	9.1	9.1	9.1	2.6	2.6	2.6	3.51	4.4	4.4	4.4
-6	8.9	8.9	8.9	2.6	2.6	2.6	3.46	4.4	4.4	4.4
-7	8.8	8.8	8.8	2.6	2.6	2.6	3.41	4.4	4.4	4.4
-8	8.7	8.7	8.7	2.6	2.6	2.6	3.36	4.4	4.4	4.4
-9	8.6	8.6	8.6	2.6	2.6	2.6	3.32	4.4	4.4	4.4
-10	8.5	8.5	8.5	2.6	2.6	2.6	3.29	4.4	4.4	4.4
-11	8.3	8.3	8.3	2.6	2.6	2.6	3.21	4.4	4.4	4.4
-12	8.1	8.1	8.1	2.6	2.6	2.6	3.13	4.4	4.4	4.4
-13	7.9	7.9	7.9	2.6	2.6	2.6	3.06	4.4	4.4	4.4
-14	7.7	7.7	7.7	2.6	2.6	2.6	2.98	4.3	4.3	4.3
-15	7.5	7.5	7.5	2.6	2.6	2.6	2.91	4.3	4.3	4.3
-16	7.3	7.3	7.3	2.6	2.6	2.6	2.84	4.3	4.3	4.3
-17	7.1	7.1	7.1	2.6	2.6	2.6	2.77	4.3	4.3	4.3
-18	6.9	6.9	6.9	2.6	2.6	2.6	2.70	4.3	4.3	4.3
-19	6.7	6.7	6.7	2.6	2.6	2.6	2.64	4.3	4.3	4.3
-20	6.6	6.6	6.6	2.5	2.5	2.5	2.57	4.3	4.3	4.3
-21	6.4	6.4	6.4	2.5	2.5	2.5	2.51	4.3	4.3	4.3
-22	6.2	6.2	6.2	2.5	2.5	2.5	2.45	4.3	4.3	4.3
-23	6.1	6.1	6.1	2.5	2.5	2.5	2.39	4.3	4.3	4.3
-24	5.9	5.9	5.9	2.5	2.5	2.5	2.33	4.3	4.3	4.3
-25	5.8	5.8	5.8	2.5	2.5	2.5	2.27	4.3	4.3	4.3

* Achtung: Betriebsgrenzen beachten - nicht in Tabelle festgehalten

ZHI11K1P-TFM_R410A_1_AW

Th [°C]		45 °C								
Ta [°C]	Qh nom [kW]	Qh min [kW]	Qh max [kW]	Pin nom [kW]	Pin-min [kW]	Pin-max [kW]	COP kW / kW	I nom [A]	I min [A]	I max [A]
25	18.3	18.3	18.3	3.0	3.0	3.0	6.02	4.9	4.9	4.9
24	18.0	18.0	18.0	3.1	3.1	3.1	5.86	4.9	4.9	4.9
23	17.6	17.6	17.6	3.1	3.1	3.1	5.70	5.0	5.0	5.0
22	17.3	17.3	17.3	3.1	3.1	3.1	5.55	5.0	5.0	5.0
21	17.0	17.0	17.0	3.1	3.1	3.1	5.41	5.0	5.0	5.0
20	16.6	16.6	16.6	3.2	3.2	3.2	5.27	5.0	5.0	5.0
19	16.3	16.3	16.3	3.2	3.2	3.2	5.14	5.1	5.1	5.1
18	16.0	16.0	16.0	3.2	3.2	3.2	5.01	5.1	5.1	5.1
17	15.7	15.7	15.7	3.2	3.2	3.2	4.89	5.1	5.1	5.1
16	15.4	15.4	15.4	3.2	3.2	3.2	4.77	5.1	5.1	5.1
15	15.1	15.1	15.1	3.2	3.2	3.2	4.65	5.1	5.1	5.1
14	14.8	14.8	14.8	3.2	3.2	3.2	4.54	5.1	5.1	5.1
13	14.5	14.5	14.5	3.3	3.3	3.3	4.44	5.2	5.2	5.2
12	14.2	14.2	14.2	3.3	3.3	3.3	4.33	5.2	5.2	5.2
11	13.9	13.9	13.9	3.3	3.3	3.3	4.23	5.2	5.2	5.2
10	13.6	13.6	13.6	3.3	3.3	3.3	4.14	5.2	5.2	5.2
9	13.1	13.1	13.1	3.3	3.3	3.3	3.99	5.2	5.2	5.2
8	12.7	12.7	12.7	3.3	3.3	3.3	3.85	5.2	5.2	5.2
7	12.3	12.3	12.3	3.3	3.3	3.3	3.72	5.2	5.2	5.2
6	12.0	12.0	12.0	3.3	3.3	3.3	3.61	5.2	5.2	5.2
5	11.6	11.6	11.6	3.3	3.3	3.3	3.50	5.2	5.2	5.2
4	11.3	11.3	11.3	3.3	3.3	3.3	3.40	5.2	5.2	5.2
3	11.0	11.0	11.0	3.3	3.3	3.3	3.30	5.2	5.2	5.2
2	10.7	10.7	10.7	3.3	3.3	3.3	3.22	5.2	5.2	5.2
1	10.4	10.4	10.4	3.3	3.3	3.3	3.14	5.2	5.2	5.2
0	10.2	10.2	10.2	3.3	3.3	3.3	3.07	5.2	5.2	5.2
-1	10.0	10.0	10.0	3.3	3.3	3.3	3.00	5.2	5.2	5.2
-2	9.8	9.8	9.8	3.3	3.3	3.3	2.94	5.2	5.2	5.2
-3	9.6	9.6	9.6	3.3	3.3	3.3	2.89	5.2	5.2	5.2
-4	9.4	9.4	9.4	3.3	3.3	3.3	2.84	5.2	5.2	5.2
-5	9.2	9.2	9.2	3.3	3.3	3.3	2.79	5.2	5.2	5.2
-6	9.1	9.1	9.1	3.3	3.3	3.3	2.75	5.2	5.2	5.2
-7	9.0	9.0	9.0	3.3	3.3	3.3	2.71	5.2	5.2	5.2
-8	8.9	8.9	8.9	3.3	3.3	3.3	2.68	5.2	5.2	5.2
-9	8.8	8.8	8.8	3.3	3.3	3.3	2.65	5.2	5.2	5.2
-10	8.7	8.7	8.7	3.3	3.3	3.3	2.63	5.2	5.2	5.2
-11	8.5	8.5	8.5	3.3	3.3	3.3	2.57	5.2	5.2	5.2
-12	8.3	8.3	8.3	3.3	3.3	3.3	2.51	5.2	5.2	5.2
-13	8.1	8.1	8.1	3.3	3.3	3.3	2.45	5.2	5.2	5.2
-14	7.9	7.9	7.9	3.3	3.3	3.3	2.40	5.2	5.2	5.2
-15	7.7	7.7	7.7	3.3	3.3	3.3	2.35	5.2	5.2	5.2
-16	7.5	7.5	7.5	3.3	3.3	3.3	2.29	5.2	5.2	5.2
-17	7.4	7.4	7.4	3.3	3.3	3.3	2.24	5.2	5.2	5.2
-18	7.2	7.2	7.2	3.3	3.3	3.3	2.19	5.2	5.2	5.2
-19	7.0	7.0	7.0	3.3	3.3	3.3	2.14	5.2	5.2	5.2
-20	6.9	6.9	6.9	3.3	3.3	3.3	2.09	5.2	5.2	5.2
-21	6.7	6.7	6.7	3.3	3.3	3.3	2.04	5.2	5.2	5.2
-22	6.5	6.5	6.5	3.3	3.3	3.3	2.00	5.2	5.2	5.2
-23	6.4	6.4	6.4	3.3	3.3	3.3	1.95	5.2	5.2	5.2
-24	6.2	6.2	6.2	3.3	3.3	3.3	1.91	5.2	5.2	5.2
-25	6.1	6.1	6.1	3.3	3.3	3.3	1.86	5.2	5.2	5.2

* Achtung: Betriebsgrenzen beachten - nicht in Tabelle festgehalten

Th [°C]		55 °C								
Ta [°C]	Qh nom [kW]	Qh min [kW]	Qh max [kW]	Pin nom [kW]	Pin-min [kW]	Pin-max [kW]	COP kW / kW	I nom [A]	I min [A]	I max [A]
25	17.9	17.9	17.9	4.1	4.1	4.1	4.35	6.2	6.2	6.2
24	17.5	17.5	17.5	4.1	4.1	4.1	4.25	6.2	6.2	6.2
23	17.2	17.2	17.2	4.1	4.1	4.1	4.15	6.3	6.3	6.3
22	16.9	16.9	16.9	4.2	4.2	4.2	4.06	6.3	6.3	6.3
21	16.6	16.6	16.6	4.2	4.2	4.2	3.98	6.3	6.3	6.3
20	16.3	16.3	16.3	4.2	4.2	4.2	3.89	6.3	6.3	6.3
19	16.0	16.0	16.0	4.2	4.2	4.2	3.81	6.3	6.3	6.3
18	15.7	15.7	15.7	4.2	4.2	4.2	3.73	6.4	6.4	6.4
17	15.4	15.4	15.4	4.2	4.2	4.2	3.65	6.4	6.4	6.4
16	15.1	15.1	15.1	4.2	4.2	4.2	3.57	6.4	6.4	6.4
15	14.9	14.9	14.9	4.2	4.2	4.2	3.50	6.4	6.4	6.4
14	14.6	14.6	14.6	4.3	4.3	4.3	3.43	6.4	6.4	6.4
13	14.3	14.3	14.3	4.3	4.3	4.3	3.36	6.4	6.4	6.4
12	14.0	14.0	14.0	4.3	4.3	4.3	3.29	6.4	6.4	6.4
11	13.8	13.8	13.8	4.3	4.3	4.3	3.22	6.4	6.4	6.4
10	13.5	13.5	13.5	4.3	4.3	4.3	3.16	6.4	6.4	6.4
9	13.1	13.1	13.1	4.3	4.3	4.3	3.06	6.4	6.4	6.4
8	12.7	12.7	12.7	4.3	4.3	4.3	2.96	6.4	6.4	6.4
7	12.3	12.3	12.3	4.3	4.3	4.3	2.88	6.4	6.4	6.4
6	12.0	12.0	12.0	4.3	4.3	4.3	2.80	6.5	6.5	6.5
5	11.7	11.7	11.7	4.3	4.3	4.3	2.72	6.5	6.5	6.5
4	11.4	11.4	11.4	4.3	4.3	4.3	2.65	6.5	6.5	6.5
3	11.1	11.1	11.1	4.3	4.3	4.3	2.59	6.5	6.5	6.5
2	10.9	10.9	10.9	4.3	4.3	4.3	2.53	6.5	6.5	6.5
1	10.6	10.6	10.6	4.3	4.3	4.3	2.47	6.4	6.4	6.4
0	10.4	10.4	10.4	4.3	4.3	4.3	2.42	6.4	6.4	6.4
-1	10.2	10.2	10.2	4.3	4.3	4.3	2.38	6.4	6.4	6.4
-2	10.0	10.0	10.0	4.3	4.3	4.3	2.33	6.4	6.4	6.4
-3	9.8	9.8	9.8	4.3	4.3	4.3	2.29	6.4	6.4	6.4
-4	9.7	9.7	9.7	4.3	4.3	4.3	2.26	6.4	6.4	6.4
-5	9.5	9.5	9.5	4.3	4.3	4.3	2.23	6.4	6.4	6.4
-6	9.4	9.4	9.4	4.3	4.3	4.3	2.20	6.4	6.4	6.4
-7	9.3	9.3	9.3	4.3	4.3	4.3	2.17	6.4	6.4	6.4
-8	9.2	9.2	9.2	4.3	4.3	4.3	2.15	6.4	6.4	6.4
-9	9.1	9.1	9.1	4.3	4.3	4.3	2.13	6.4	6.4	6.4
-10	9.0	9.0	9.0	4.3	4.3	4.3	2.11	6.4	6.4	6.4
-11	8.8	8.8	8.8	4.3	4.3	4.3	2.07	6.4	6.4	6.4
-12	8.7	8.7	8.7	4.3	4.3	4.3	2.03	6.4	6.4	6.4
-13	8.5	8.5	8.5	4.3	4.3	4.3	1.99	6.4	6.4	6.4
-14	8.3	8.3	8.3	4.3	4.3	4.3	1.95	6.4	6.4	6.4
-15	8.1	8.1	8.1	4.3	4.3	4.3	1.91	6.4	6.4	6.4
-16	8.0	8.0	8.0	4.3	4.3	4.3	1.87	6.4	6.4	6.4
-17	7.8	7.8	7.8	4.3	4.3	4.3	1.83	6.4	6.4	6.4
-18	7.7	7.7	7.7	4.3	4.3	4.3	1.80	6.4	6.4	6.4
-19	7.5	7.5	7.5	4.3	4.3	4.3	1.76	6.4	6.4	6.4
-20	7.4	7.4	7.4	4.3	4.3	4.3	1.72	6.4	6.4	6.4
-21	7.2	7.2	7.2	4.3	4.3	4.3	1.69	6.4	6.4	6.4
-22	7.1	7.1	7.1	4.3	4.3	4.3	1.66	6.4	6.4	6.4
-23	6.9	6.9	6.9	4.3	4.3	4.3	1.62	6.4	6.4	6.4
-24	6.8	6.8	6.8	4.3	4.3	4.3	1.59	6.4	6.4	6.4
-25	6.7	6.7	6.7	4.3	4.3	4.3	1.56	6.4	6.4	6.4

* Achtung: Betriebsgrenzen beachten - nicht in Tabelle festgehalten

Th [°C]		T-Max @ 65 °C								
Ta [°C]	Qh nom [kW]	Qh min [kW]	Qh max [kW]	Pin nom [kW]	Pin-min [kW]	Pin-max [kW]	COP kW / kW	I nom [A]	I min [A]	I max [A]
25	17.4	17.4	17.4	5.4	5.4	5.4	3.21	8.0	8.0	8.0
24	17.1	17.1	17.1	5.4	5.4	5.4	3.15	8.0	8.0	8.0
23	16.8	16.8	16.8	5.5	5.5	5.5	3.09	8.0	8.0	8.0
22	16.6	16.6	16.6	5.5	5.5	5.5	3.03	8.0	8.0	8.0
21	16.3	16.3	16.3	5.5	5.5	5.5	2.97	8.0	8.0	8.0
20	16.0	16.0	16.0	5.5	5.5	5.5	2.92	8.0	8.0	8.0
19	15.7	15.7	15.7	5.5	5.5	5.5	2.87	8.1	8.1	8.1
18	15.5	15.5	15.5	5.5	5.5	5.5	2.81	8.1	8.1	8.1
17	15.2	15.2	15.2	5.5	5.5	5.5	2.76	8.1	8.1	8.1
16	15.0	15.0	15.0	5.5	5.5	5.5	2.71	8.1	8.1	8.1
15	14.7	14.7	14.7	5.5	5.5	5.5	2.66	8.1	8.1	8.1
14	14.5	14.5	14.5	5.5	5.5	5.5	2.62	8.1	8.1	8.1
13	14.2	14.2	14.2	5.5	5.5	5.5	2.57	8.1	8.1	8.1
12	14.0	14.0	14.0	5.5	5.5	5.5	2.53	8.1	8.1	8.1
11	13.7	13.7	13.7	5.5	5.5	5.5	2.48	8.1	8.1	8.1
10	13.5	13.5	13.5	5.5	5.5	5.5	2.44	8.1	8.1	8.1
9	13.2	13.2	13.2	5.5	5.5	5.5	2.37	8.1	8.1	8.1
8	12.8	12.8	12.8	5.5	5.5	5.5	2.31	8.1	8.1	8.1
7	12.5	12.5	12.5	5.6	5.6	5.6	2.25	8.1	8.1	8.1
6	12.2	12.2	12.2	5.6	5.6	5.6	2.20	8.1	8.1	8.1
5	11.9	11.9	11.9	5.6	5.6	5.6	2.15	8.1	8.1	8.1
4	11.7	11.7	11.7	5.6	5.6	5.6	2.10	8.1	8.1	8.1
3	11.4	11.4	11.4	5.6	5.6	5.6	2.05	8.1	8.1	8.1
2	11.2	11.2	11.2	5.6	5.6	5.6	2.01	8.1	8.1	8.1
1	11.0	11.0	11.0	5.6	5.6	5.6	1.98	8.1	8.1	8.1
0	10.8	10.8	10.8	5.6	5.6	5.6	1.94	8.1	8.1	8.1
-1	10.6	10.6	10.6	5.6	5.6	5.6	1.91	8.1	8.1	8.1
-2	10.4	10.4	10.4	5.6	5.6	5.6	1.88	8.1	8.1	8.1
-3	10.3	10.3	10.3	5.6	5.6	5.6	1.85	8.1	8.1	8.1
-4	10.1	10.1	10.1	5.6	5.6	5.6	1.83	8.1	8.1	8.1
-5	10.0	10.0	10.0	5.6	5.6	5.6	1.80	8.1	8.1	8.1
-6	9.9	9.9	9.9	5.6	5.6	5.6	1.78	8.1	8.1	8.1
-7	9.8	9.8	9.8	5.6	5.6	5.6	1.77	8.1	8.1	8.1
-8	9.7	9.7	9.7	5.6	5.6	5.6	1.75	8.1	8.1	8.1
-9	9.6	9.6	9.6	5.6	5.6	5.6	1.74	8.1	8.1	8.1
-10	9.6	9.6	9.6	5.6	5.6	5.6	1.72	8.1	8.1	8.1
-11	9.4	9.4	9.4	5.6	5.6	5.6	1.70	8.1	8.1	8.1
-12	9.3	9.3	9.3	5.6	5.6	5.6	1.67	8.1	8.1	8.1
-13	9.1	9.1	9.1	5.6	5.6	5.6	1.64	8.1	8.1	8.1
-14	9.0	9.0	9.0	5.6	5.6	5.6	1.61	8.1	8.1	8.1
-15	8.8	8.8	8.8	5.6	5.6	5.6	1.59	8.1	8.1	8.1
-16										
-17										
-18										
-19										
-20										
-21										
-22										
-23										
-24										
-25										

* Achtung: Betriebsgrenzen beachten - nicht in Tabelle festgehalten

Tc [°C]		W 12 / 7 °C								
Ta [°C]	Qc nom [kW]	Qc min [kW]	Qc max [kW]	Pin [kW]	Pin min [kW]	Pin max [kW]	EER kW / kW	I nom [A]	I min [A]	I max [A]
40	8.2	8.2	8.2	3.6	3.6	3.6	2.29	5.6	5.6	5.6
39	8.3	8.3	8.3	3.5	3.5	3.5	2.37	5.4	5.4	5.4
38	8.3	8.3	8.3	3.4	3.4	3.4	2.45	5.3	5.3	5.3
37	8.4	8.4	8.4	3.3	3.3	3.3	2.53	5.2	5.2	5.2
36	8.5	8.5	8.5	3.2	3.2	3.2	2.62	5.1	5.1	5.1
35	8.6	8.6	8.6	3.2	3.2	3.2	2.71	5.0	5.0	5.0
34	8.6	8.6	8.6	3.1	3.1	3.1	2.80	4.9	4.9	4.9
33	8.7	8.7	8.7	3.0	3.0	3.0	2.90	4.8	4.8	4.8
32	8.7	8.7	8.7	2.9	2.9	2.9	2.99	4.8	4.8	4.8
31	8.8	8.8	8.8	2.9	2.9	2.9	3.09	4.7	4.7	4.7
30	8.9	8.9	8.9	2.8	2.8	2.8	3.19	4.6	4.6	4.6
29	8.9	8.9	8.9	2.7	2.7	2.7	3.30	4.5	4.5	4.5
28	9.0	9.0	9.0	2.6	2.6	2.6	3.41	4.4	4.4	4.4
27	9.0	9.0	9.0	2.6	2.6	2.6	3.52	4.3	4.3	4.3
26	9.1	9.1	9.1	2.5	2.5	2.5	3.63	4.3	4.3	4.3
25	9.2	9.2	9.2	2.4	2.4	2.4	3.75	4.2	4.2	4.2
24	9.2	9.2	9.2	2.4	2.4	2.4	3.87	4.1	4.1	4.1
23	9.3	9.3	9.3	2.3	2.3	2.3	4.00	4.1	4.1	4.1
22	9.3	9.3	9.3	2.3	2.3	2.3	4.13	4.0	4.0	4.0
21	9.4	9.4	9.4	2.2	2.2	2.2	4.26	3.9	3.9	3.9
20	9.4	9.4	9.4	2.1	2.1	2.1	4.40	3.9	3.9	3.9
19	9.4	9.4	9.4	2.1	2.1	2.1	4.54	3.8	3.8	3.8
18	9.5	9.5	9.5	2.0	2.0	2.0	4.69	3.7	3.7	3.7
17	9.5	9.5	9.5	2.0	2.0	2.0	4.84	3.7	3.7	3.7

Tc [°C]		W 23 / 18 °C								
Ta [°C]	Qc [kW]	Qh-min [kW]	Qh-max [kW]	Pin [kW]	Pin-min [kW]	Pin-max [kW]	EER kW / kW	I [A]	I-min [A]	I-max [A]
40	11.0	11.0	11.0	3.6	3.6	3.6	3.08	5.5	5.5	5.5
39	11.1	11.1	11.1	3.5	3.5	3.5	3.19	5.4	5.4	5.4
38	11.2	11.2	11.2	3.4	3.4	3.4	3.30	5.3	5.3	5.3
37	11.3	11.3	11.3	3.3	3.3	3.3	3.41	5.2	5.2	5.2
36	11.4	11.4	11.4	3.2	3.2	3.2	3.53	5.1	5.1	5.1
35	11.5	11.5	11.5	3.2	3.2	3.2	3.65	5.0	5.0	5.0
34	11.6	11.6	11.6	3.1	3.1	3.1	3.77	4.9	4.9	4.9
33	11.7	11.7	11.7	3.0	3.0	3.0	3.90	4.8	4.8	4.8
32	11.8	11.8	11.8	2.9	2.9	2.9	4.03	4.7	4.7	4.7
31	11.9	11.9	11.9	2.9	2.9	2.9	4.16	4.6	4.6	4.6
30	11.9	11.9	11.9	2.8	2.8	2.8	4.30	4.5	4.5	4.5
29	12.0	12.0	12.0	2.7	2.7	2.7	4.44	4.4	4.4	4.4
28	12.1	12.1	12.1	2.6	2.6	2.6	4.59	4.3	4.3	4.3
27	12.2	12.2	12.2	2.6	2.6	2.6	4.74	4.2	4.2	4.2
26	12.3	12.3	12.3	2.5	2.5	2.5	4.89	4.2	4.2	4.2
25	12.3	12.3	12.3	2.4	2.4	2.4	5.05	4.1	4.1	4.1
24	12.4	12.4	12.4	2.4	2.4	2.4	5.21	4.0	4.0	4.0
23	12.5	12.5	12.5	2.3	2.3	2.3	5.38	3.9	3.9	3.9
22	12.5	12.5	12.5	2.3	2.3	2.3	5.55	3.9	3.9	3.9
21	12.6	12.6	12.6	2.2	2.2	2.2	5.73	3.8	3.8	3.8
20	12.7	12.7	12.7	2.1	2.1	2.1	5.92	3.7	3.7	3.7
19	12.7	12.7	12.7	2.1	2.1	2.1	6.11	3.6	3.6	3.6
18	12.8	12.8	12.8	2.0	2.0	2.0	6.31	3.6	3.6	3.6
17	12.8	12.8	12.8	2.0	2.0	2.0	6.52	3.5	3.5	3.5

* Achtung: Betriebsgrenzen beachten - nicht in Tabelle festgehalten

LEGENDE:

Twq-RL: Temperatur Wärmequelle - Eintritt [°C]
Tws-VL: Temperatur Wärmesenke - Vorlauf [°C]
Tk-VL: Temperatur Kältesenke - Vorlauf [°C]
Qh nom: Heizleistung nominal
Qh min: Heizleistung minimal
Qh max: Heizleistung maximal
Pin nom: Aufnahme bei nominaler Heizleistung
Pin min: Aufnahme bei minimaler Heizleistung
Pin max: Aufnahme bei maximaler Heizleistung
COP nom: Arbeitszahl bei nominaler Heizleistung
Qc nom: Kälteleistung/Energieentnahme bei nominaler Heizleistung
Qc min: Kälteleistung/Energieentnahme bei minimaler Heizleistung
Qc max: Kälteleistung/Energieentnahme bei maximaler Heizleistung
I nom: Stromaufnahme bei nominaler Heizleistung
EER: Arbeitszahl bei nominaler Kälteleistung

Betriebsgrenzen

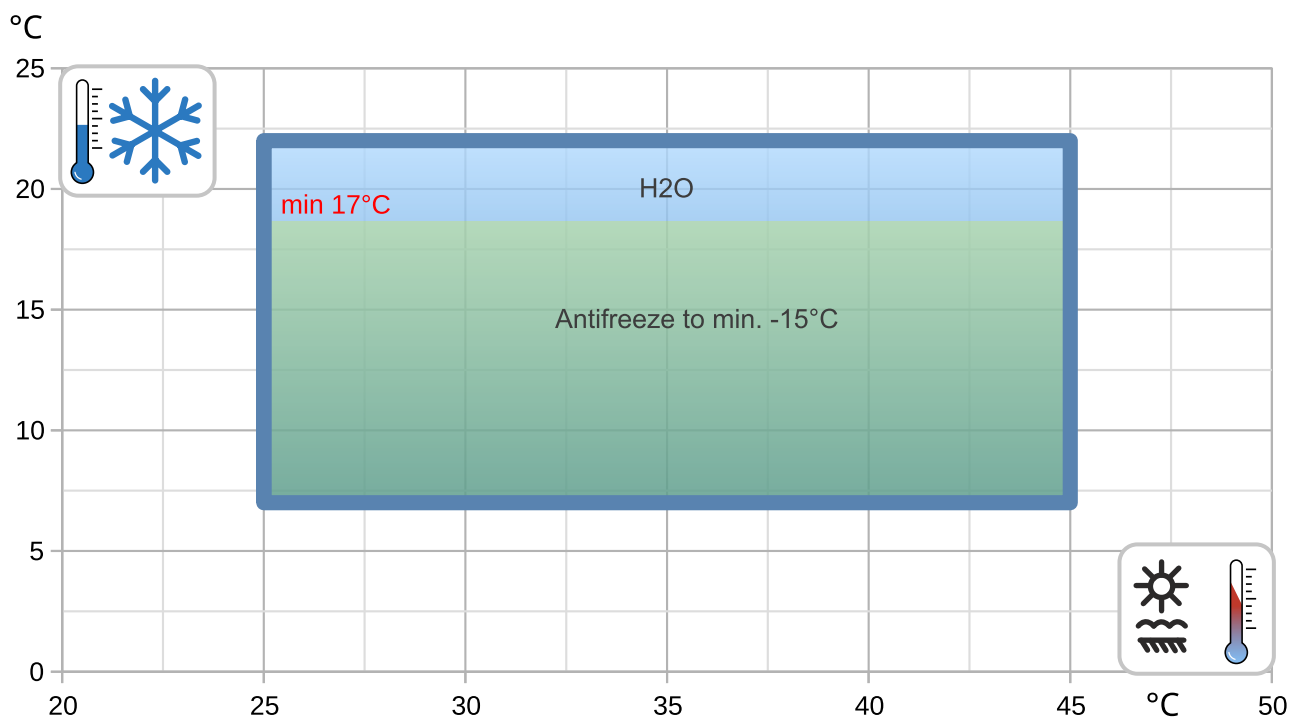
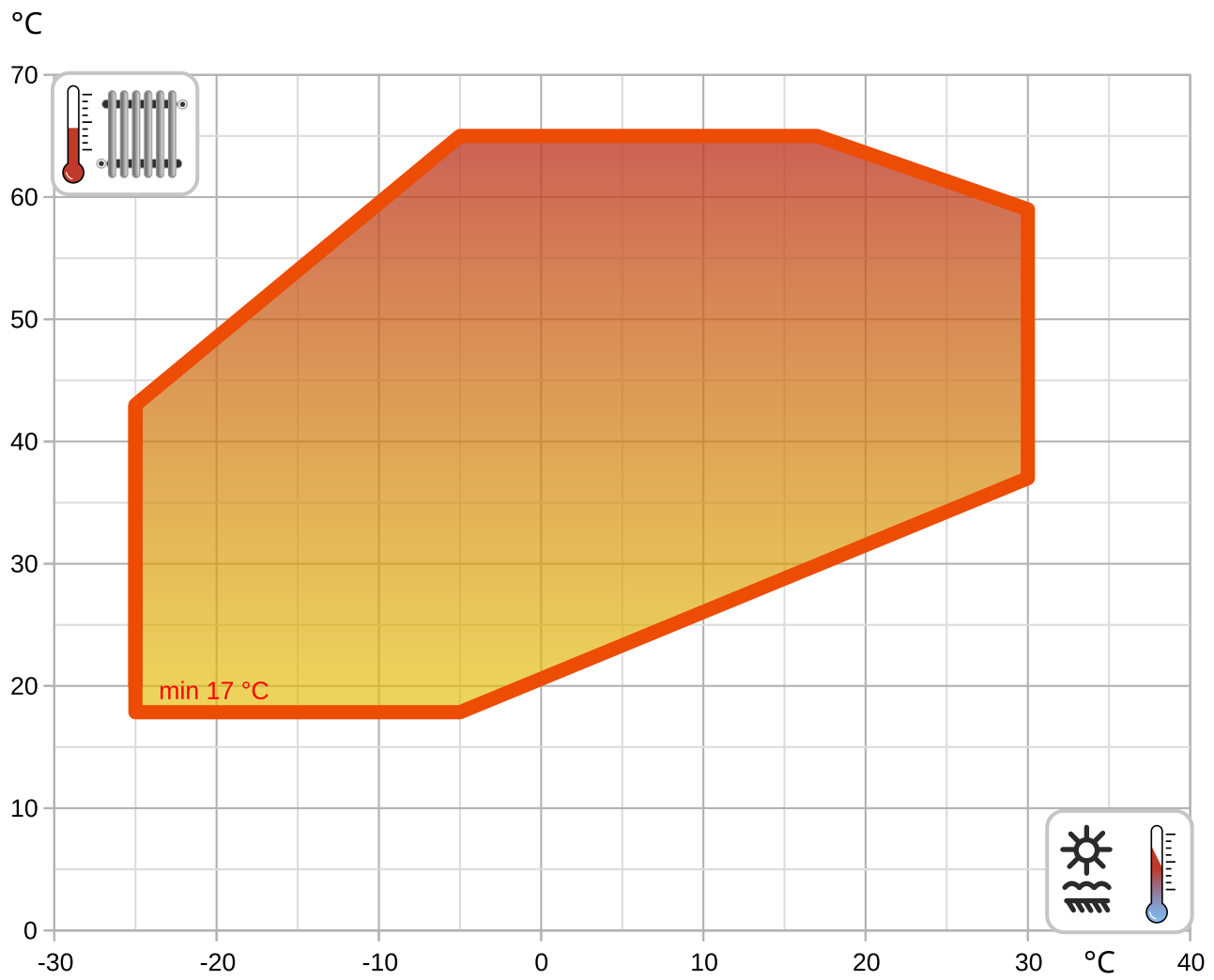

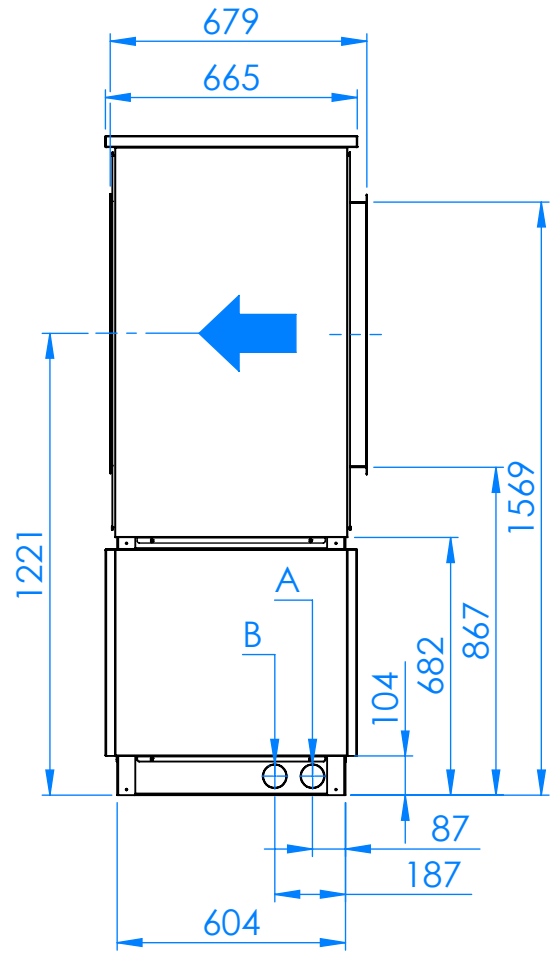
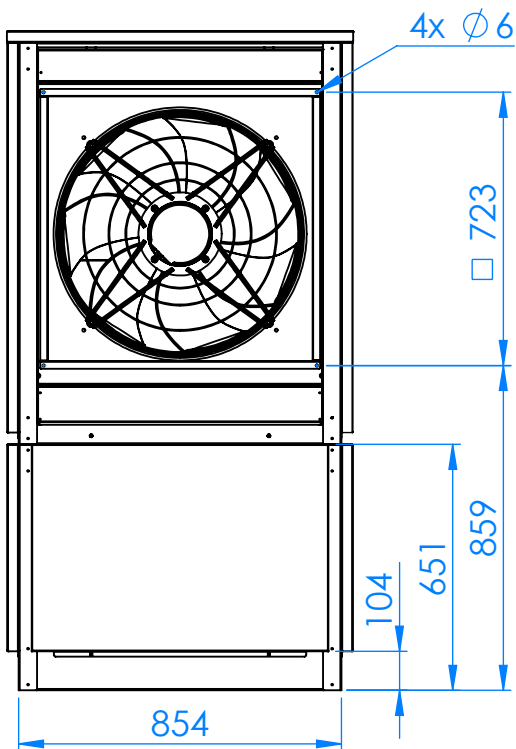
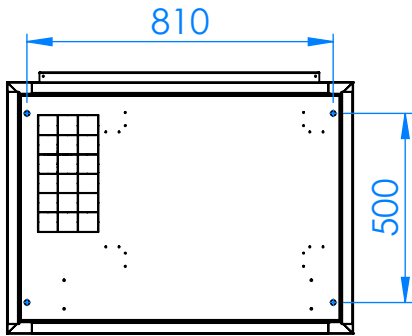
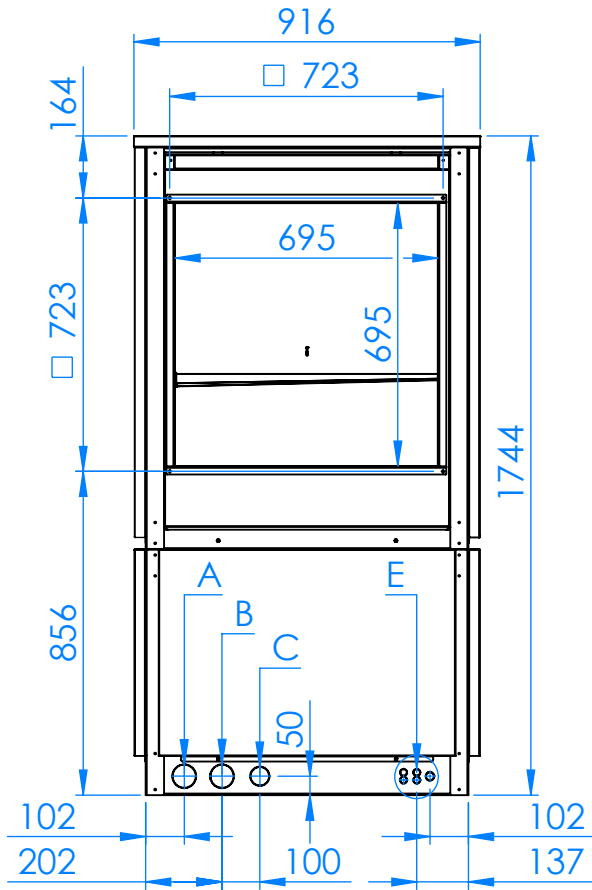

C - condens

E - electro

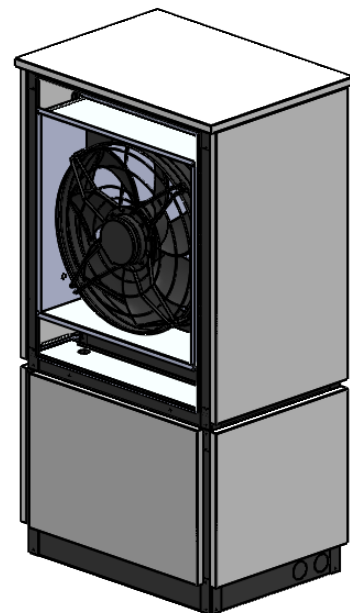

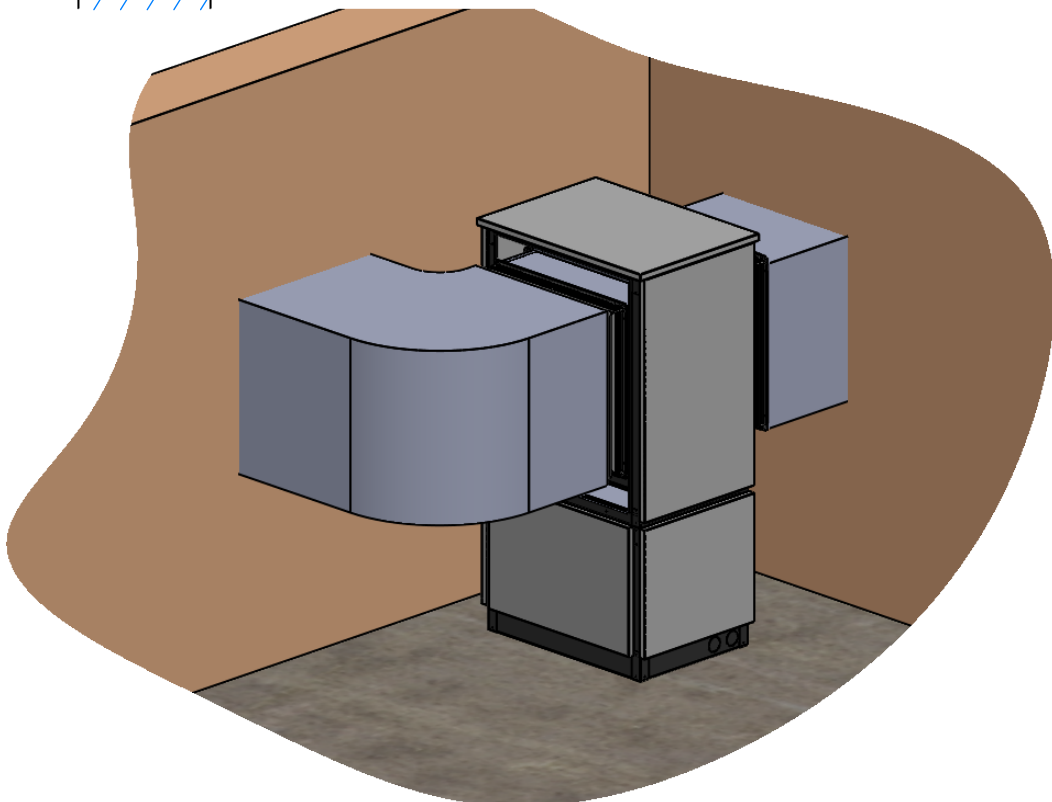
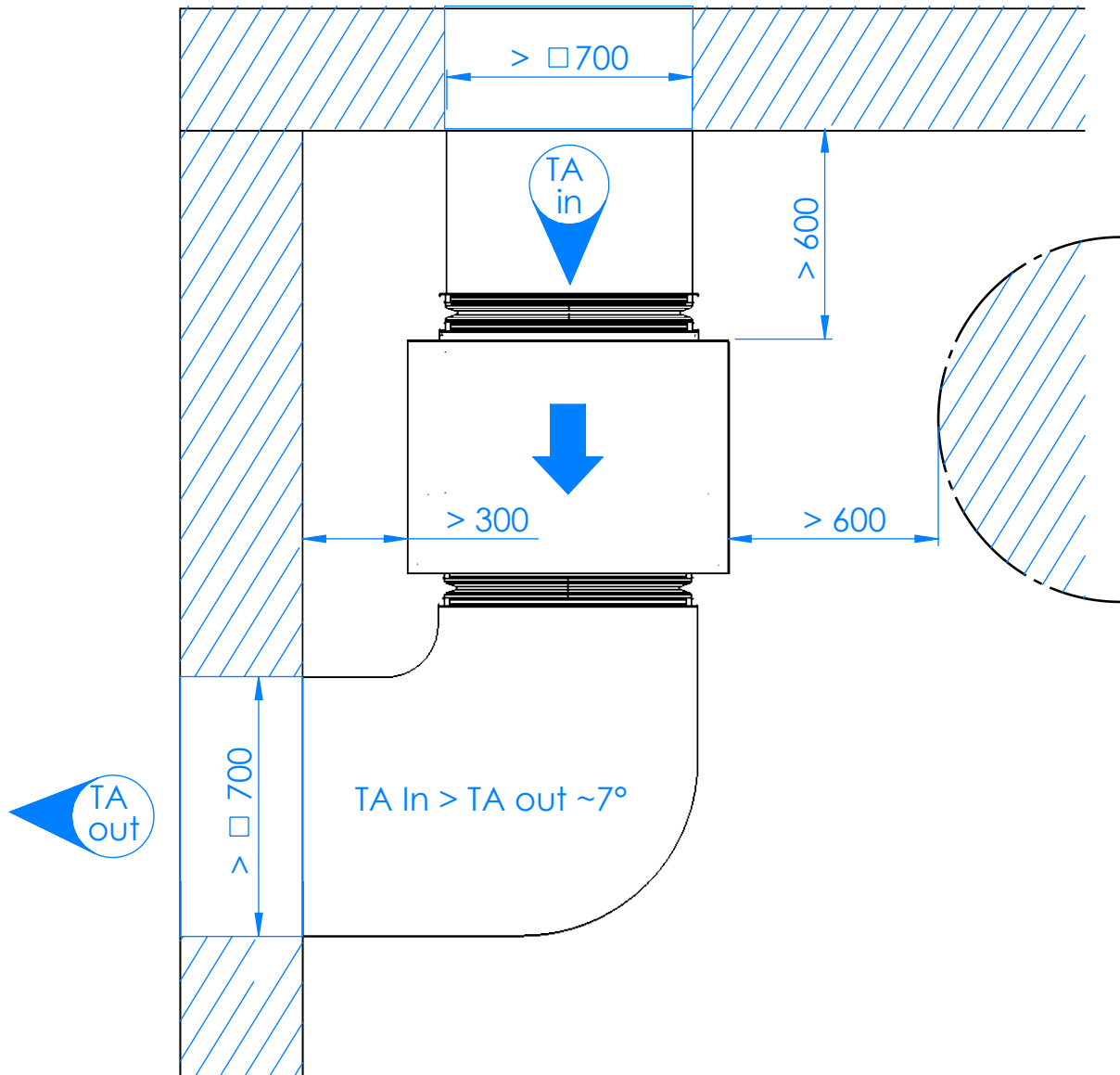

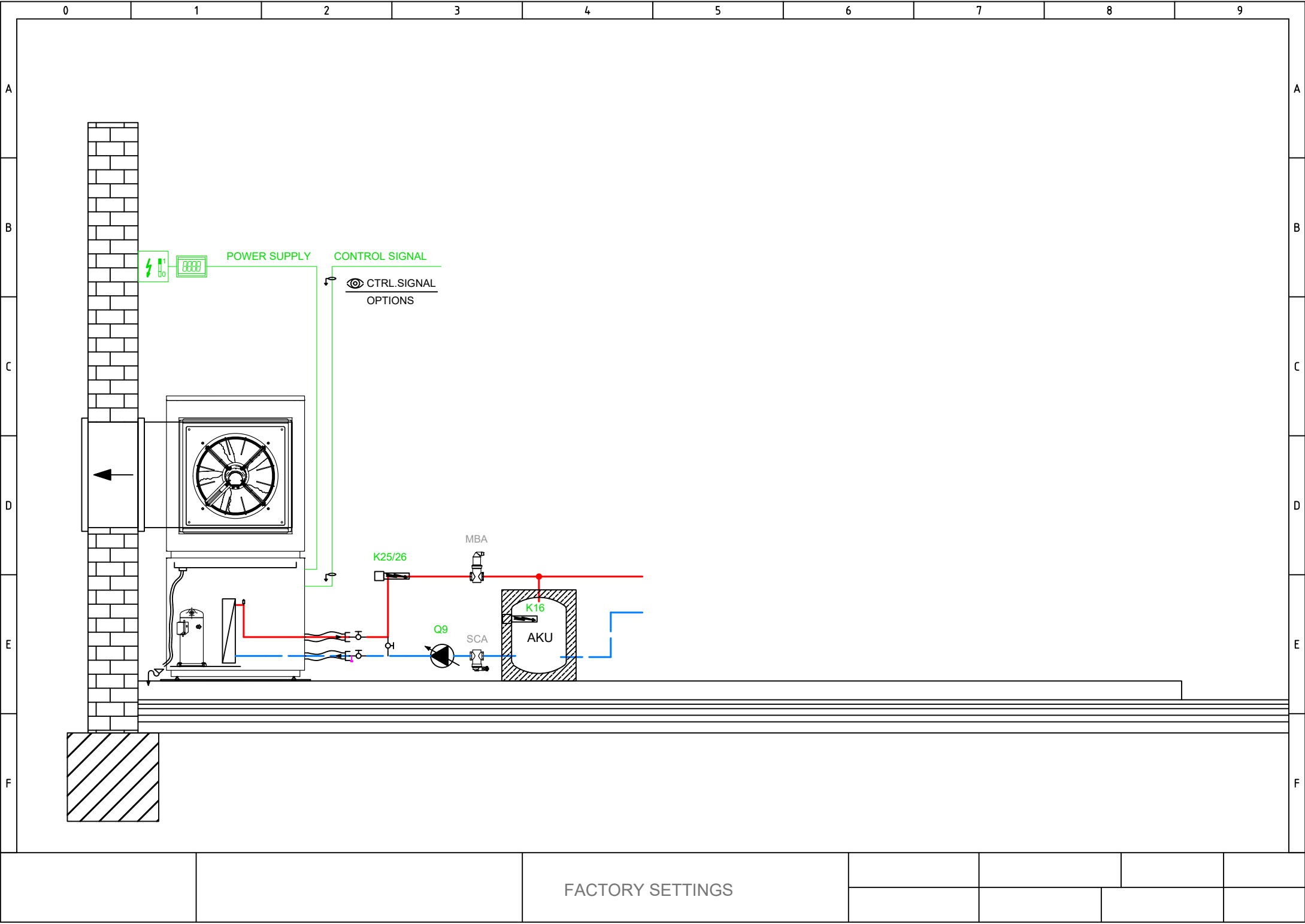

FACTORY SETTINGS

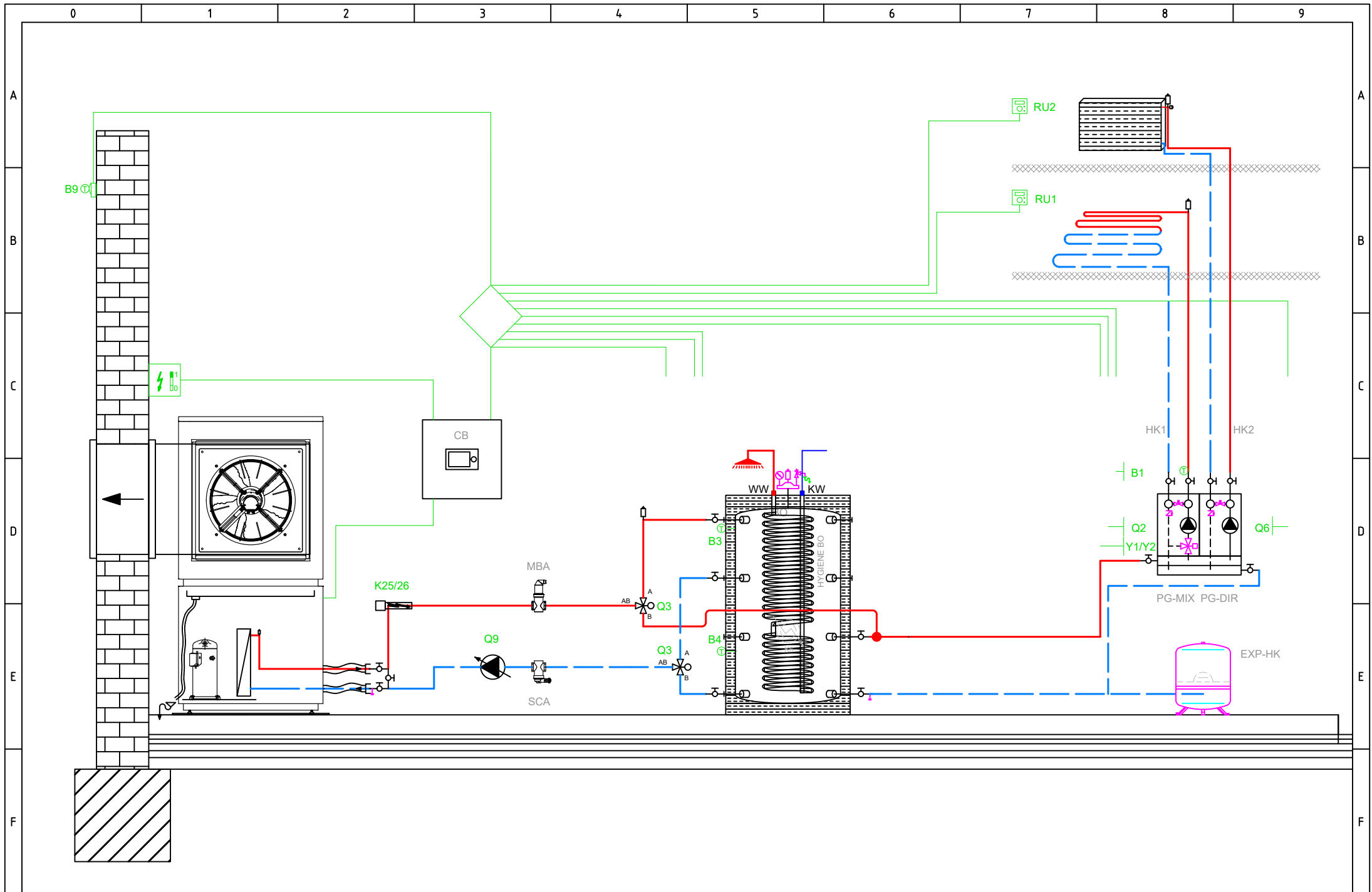

BASIC APPLICATION

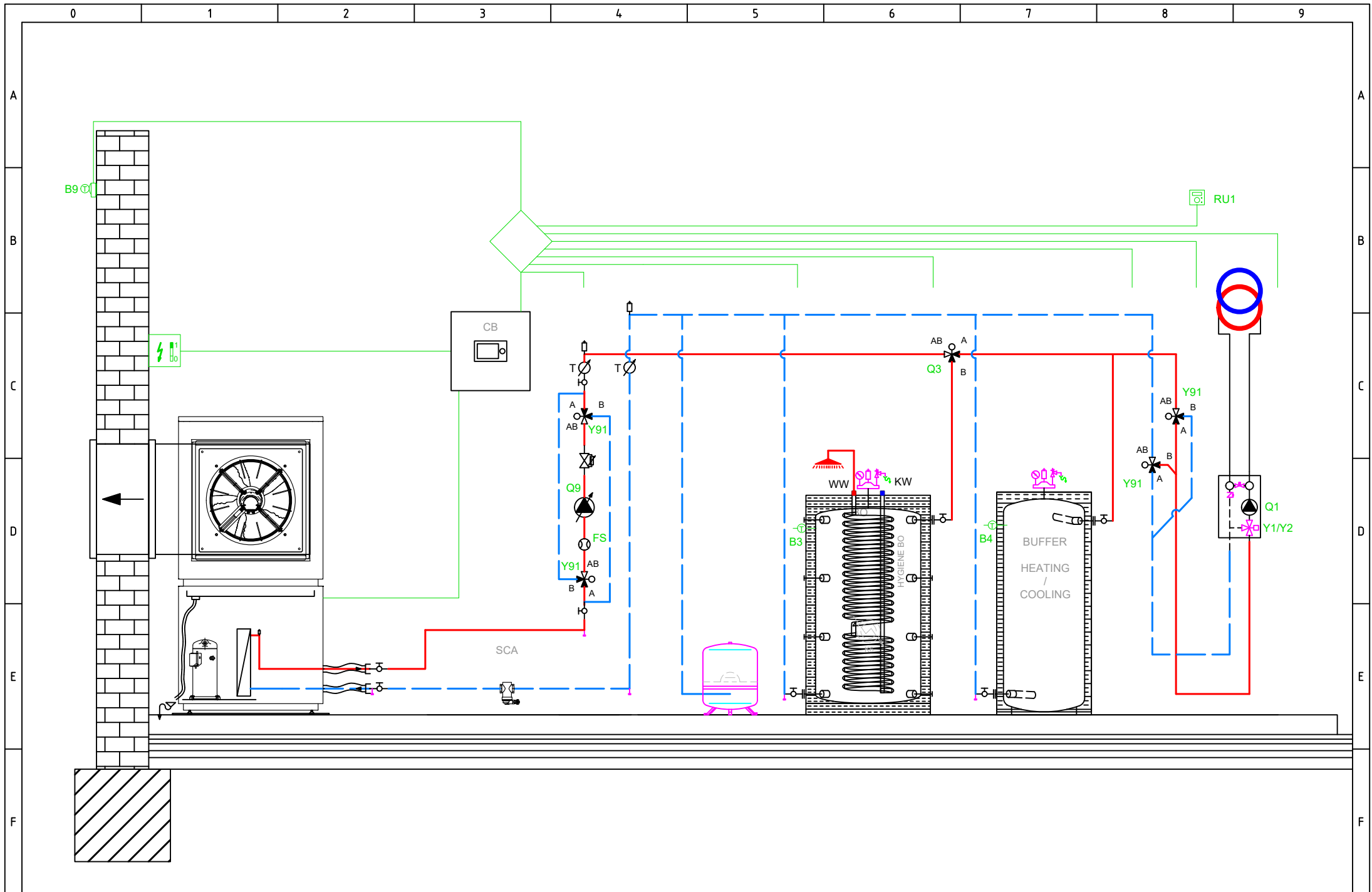

OPTIONAL APPLICATION



Netzanschluss 230V / 50 Hz

Erde
Nullleiter

- E10 Hochdruckwächter E10
- E11 Überlast Verdichter 1 E11
- E14 Überlast Quelle E14
- E24 Ström'wächter Verbrau E24
- K82 Ventil EVI K82

K40 Ölsumpfeheizung K40

- L Faze 230V
- K1 Verdichterstufe 1 K1
- Y22 Prozessumkehrventil Y22

Q9 Kondensatorpumpe Q9

X10	1	L
X10	1	PE
X10	1	N
X11	1	EX1
X11	1	EX2
X11	1	EX3
X11	1	EX4
X12	1	QX1
X12	1	N
X12	1	QX2
X12	1	QX2i
X12	1	N
X12	1	FX3
X15	1	QX3
X15	1	QX4
X15	1	QX4i
X15	1	N
X15	1	QX5
X15	1	N
X15	1	ZX6
X15	1	N
X86	1	GX1
X86	1	H3
X86	1	M
X86	1	H1
X86	1	G+
X86	1	M
X86	1	BSB

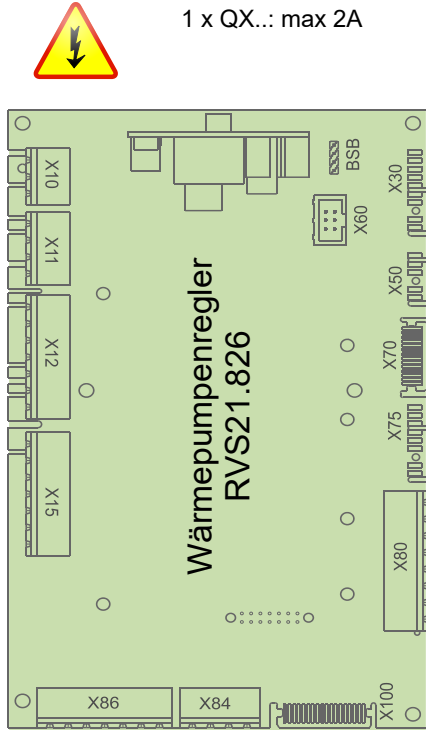

Total: max 6A
1 x QX...: max 2A

BSB
X30
X60
X50
X70

- BSB Anschluss Servicetool (OCI700)
- X30 Bediengerät (HMI) AVS37.xxx
- X60 Modbus-Clip-In OCI351.01
- X50 Erweiterungsmodul AVS75.xxx
- X70 LPB clip-in

D1
D2
D3
UX3
M
DI6
DI7
M

- D1 Digi Ausgang 1 Heizen
- D2 Digi Ausgang 2 Kühlung
- D3 Digi Ausgang 3 WP Ein/Aus
- DI6 Digi Eingang 6 Abtauen
- DI7 Digi Eingang 7 Alarm

BX1
M
BX2
M
UX1
M
UX2
M

- B91 Quelleneintrittfühler B91
- B84 Quellenaust'fühler B92/B84
- K19 Ventilator K19
- 0..10V Analogsignal
- Q9 Kondensatorpumpe Q9
- PWM Signal

BX3
M
BX4
M

- B71 WP Rücklauffühler B71
- B9 Aussentemperaturfühler B9

Netzanschluss 230V / 50 Hz

Erde
Nullleiter

K10 Alarmausgang K10

V81 EEV Verdampfer V81

X10	1	L
X10	1	PE
X10	1	N
X110	1	QX31
X110	1	QX32
X110	1	QX33
X110	1	N
X110	1	ZX34
X110	1	N
X115	1	QX35
X115	1	QX35i
X115	1	N

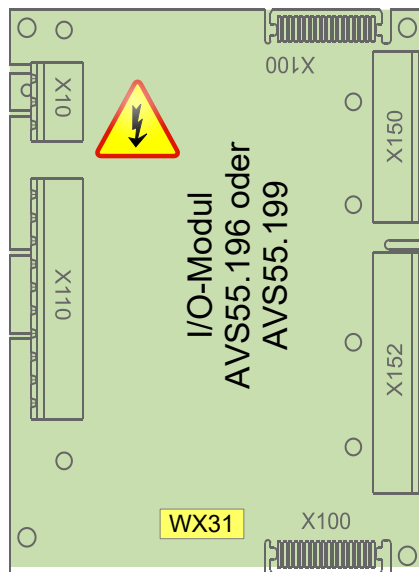

BSB
M
G+
H31
M
H32
GX1
H33
M
BX31
M
BX32
M
BX33
M
BX34
M

- 5V/12V für aktive Fühler
- Durchflussmessung 10V
- Niederdruck 0..10V
- 5V/12V für aktive Fühler
- Hochdruck 0..10V
- B21 WP Vorlauffühler B21
- B81 Heissgasfühler B81
- B85 Sauggasfühler B85
- B83 Kältemittelfühler flüssig B83



- AVS75.390
- AVS75.391
- AVS75.370

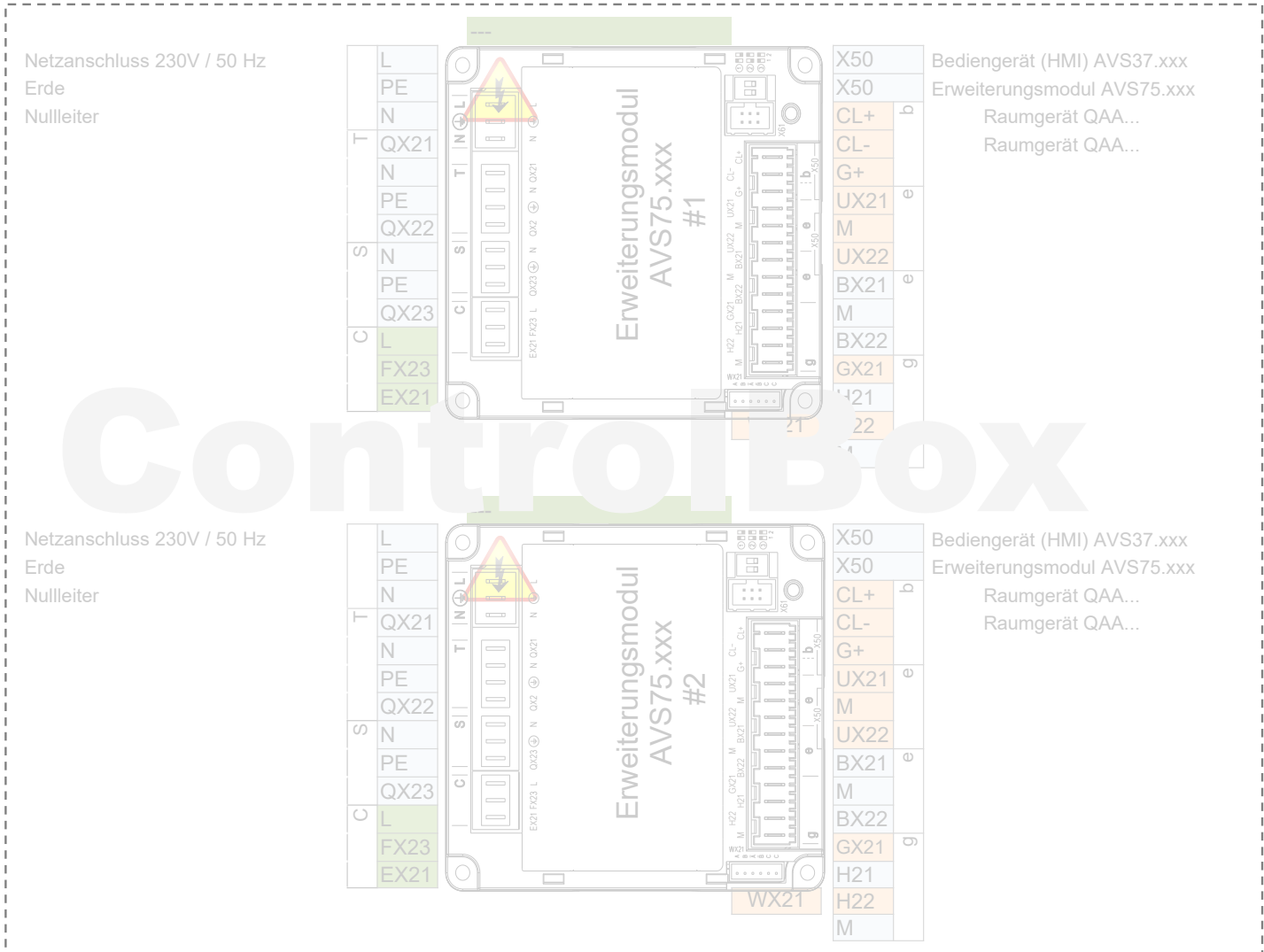

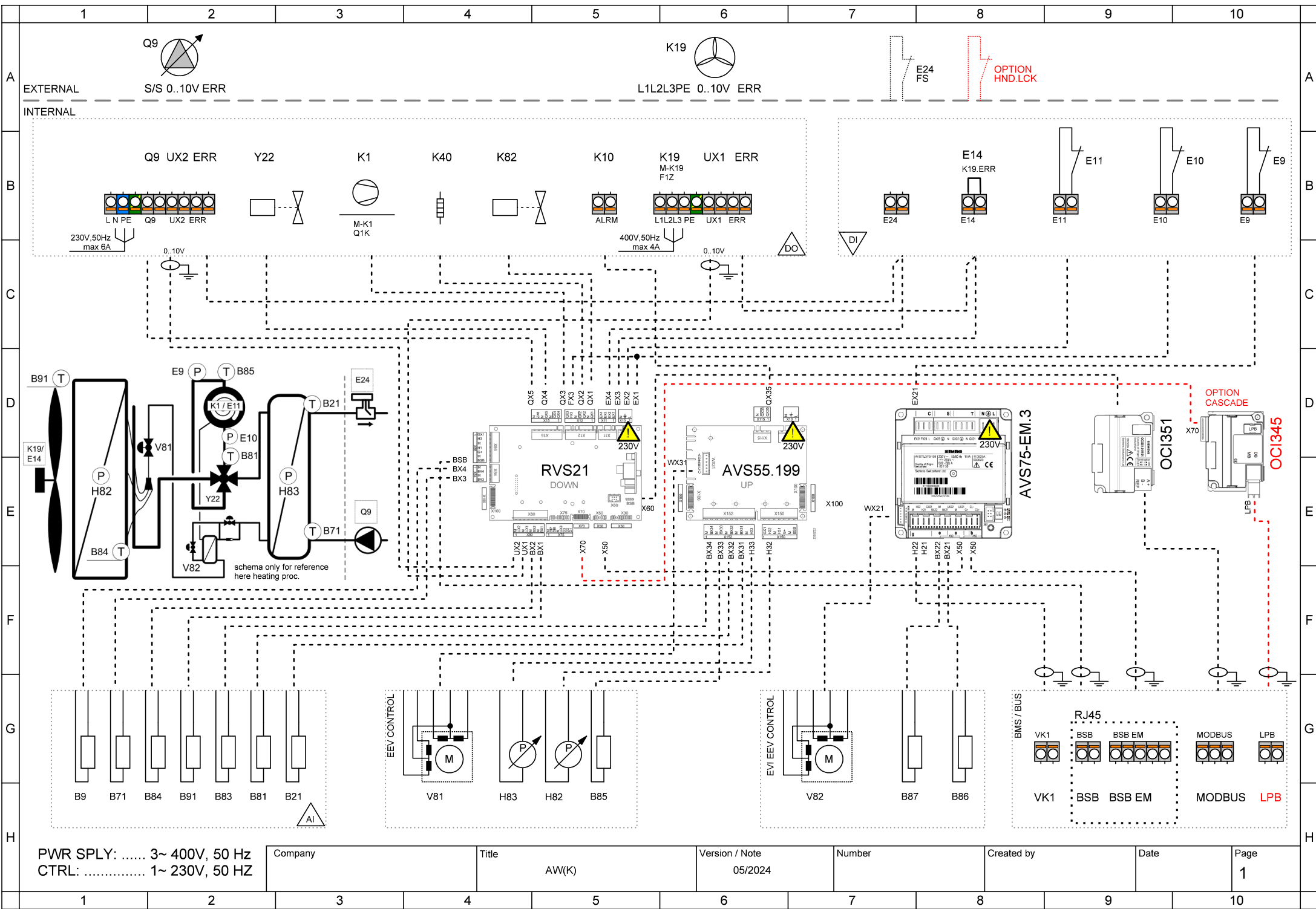

PWR SPLY: 3~ 400V, 50 Hz
 CTRL: 1~ 230V, 50 HZ

Company	Title	Version / Note	Number	Created by	Date	Page
AW(K)		05/2024				1

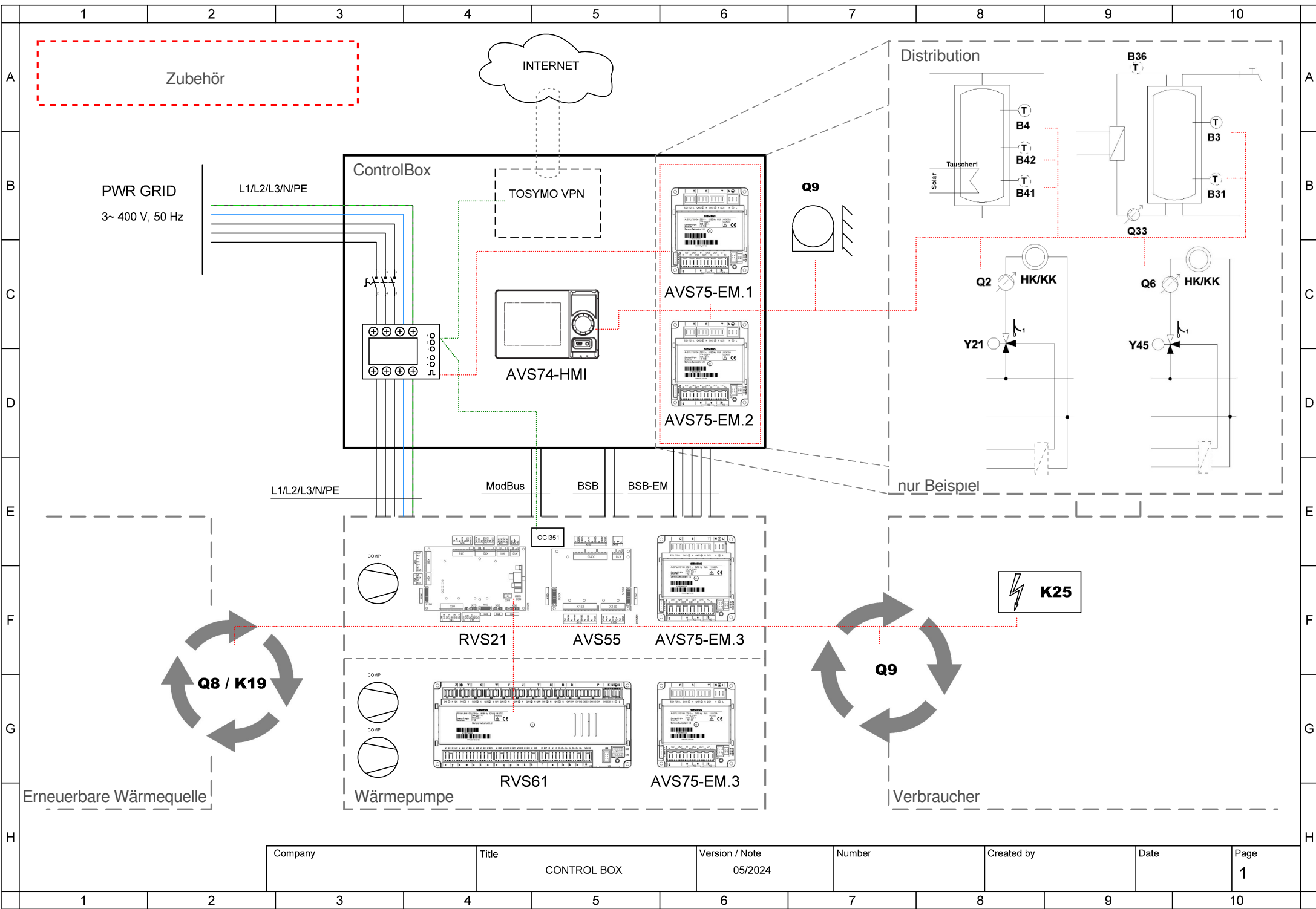

Company	Title	Version / Note	Number	Created by	Date	Page
	CONTROL BOX	05/2024				1



Company	Title	Version / Note	Number	Created by	Date	Page
	CONTROL BOX	05/2024				2



Company	Title	Version / Note	Number	Created by	Date	Page
	CONTROL BOX	05/2024				3





- AVS75.390
- AVS75.391
- AVS75.370

- AVS75.370**
 Netzanschluss 230V / 50 Hz
 Erde
 Nullleiter
Y1 Mischer Auf

Y2 Mischer Zu

Q2 Heizkreispumpe HK1 Q2

L Faze 230V
E61 Smart Grid E61

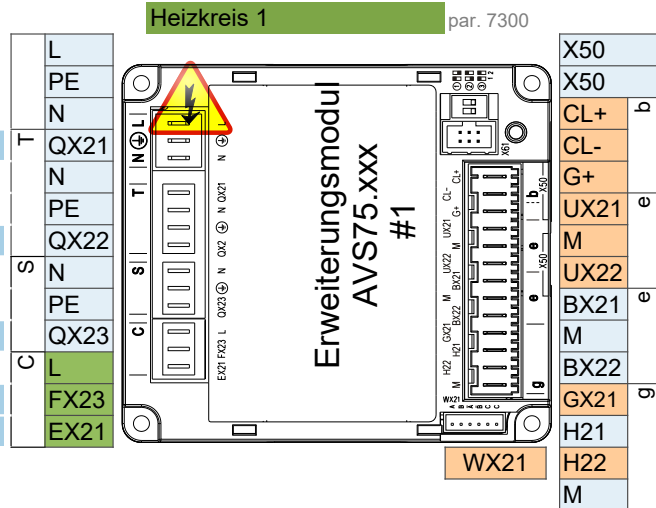

- Erweiterungsmodul AVS75.xxx
 Raumgerät QAA...
 Raumgerät QAA...

B1 Vorlauffühler 1

Impulszählung

- AVS75.370**
 Netzanschluss 230V / 50 Hz
 Erde
 Nullleiter
Q3 Trinkwasserstellglied Q3

K6 Elektroeinsatz TWW K6

Q6 Heizkreispumpe HK2 Q6

L Faze 230V
E62 Smart Grid E62

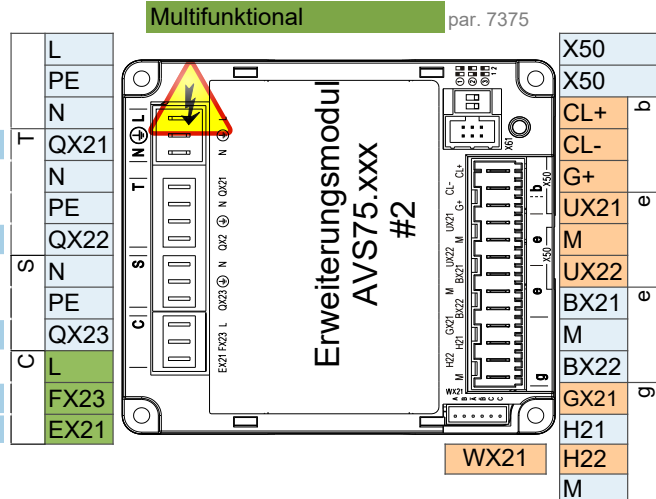

- Bediengerät (HMI) AVS37.xxx
 Erweiterungsmodul AVS75.xxx
 Raumgerät QAA...
 Raumgerät QAA...

B3 Trinkwasserfühler B3

B4 Pufferspeicherfühler B4

- Netzanschluss 230V / 50 Hz
 Erde
 Nullleiter

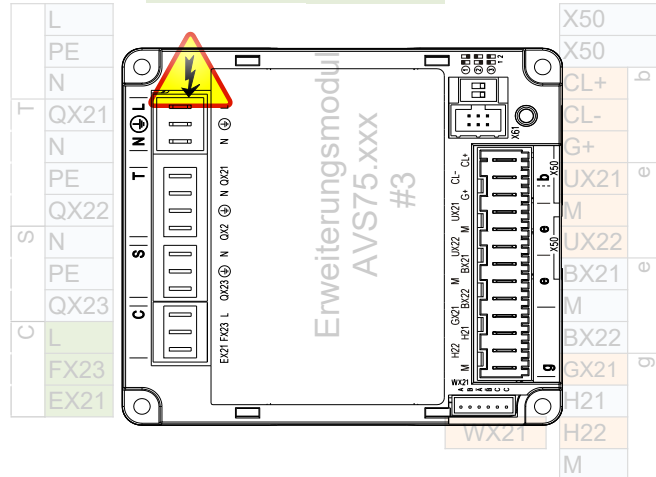

- Bediengerät (HMI) AVS37.xxx
 Erweiterungsmodul AVS75.xxx
 Raumgerät QAA...
 Raumgerät QAA...

Vorsicht: Erweiterungsmodul 3 ist in der Wärmepumpe

Anschlussmöglichkeiten für die Steuerung

1 ControlBox

ControlBox, mit zwei eingebauten Erweiterungsmodulen, ermöglicht zahlreiche Optionen für die Anwendungssteuerung auf der Verbraucherseite hinter der Wärmepumpe. Weitere Informationen finden Sie im Schaltplan der ControlBox und im Blatt mit den Anwendungsdiagrammen.

2 Fixer Sollwert Vorlauftemperatur - Ein / Aus potentialfreier Kontakt

2-adriges abgeschirmtes Kabel 2 x 0,5 mm² - Sollwert = 45°C (editierbar über Parameter 1859)

Anschlussklemme - siehe Schaltplan

3 Analog 0..10V Vorlauftemperatur-Sollwertregelung

2 Adern geschirmtes Kabel 2 x 0,5 mm² - Sollwert: 0V = 16°C ~ 10V = 60°C (editierbar im Parametersatz)

Anschlussklemme - siehe Schaltplan

4 ModBus RTU-Kommunikationsbefehl

3-adriges abgeschirmtes Kabel min. 3 x 0,25mm²

Für die ModBus-Zuordnungstabelle wenden Sie sich bitte an den technischen Support

5 MQTT IoT-Kommunikationsprotokoll

Für weitere Informationen wenden Sie sich bitte an den technischen Support